

**ADKINS**

**ADKINS**  
HEAT PRESS TECHNOLOGY

## STUDIO TWIN TABLE PNEUMATIC (PORTRAIT TABLES)



# Operators Handbook

Rev B - 23/01/19

All products within the ADKINS range are labelled with CE marking and are manufactured and tested to comply with EC safety regulations.

©2019 A. Adkins & Sons Ltd. All rights reserved. E&OE. V1.0.

# Preface

---

Dear User

**Welcome to the growing group** of Studio Twin Table Pneumatic Press users. The product you have purchased has been carefully designed and manufactured to ensure that you, the user, will gain the maximum benefit.

**All A. Adkins & Sons Limited products** are specifically designed to ensure ease of use with particular attention to safety requirements.

**Should you discover any fault** or damage upon receipt of this product, you should immediately contact your supplier.

---

# Contents

---

<b>1.</b>	<b>Introduction Studio Twin Table Pneumatic Press</b>	<b>1</b>
1.1	Specifications of the Studio Twin Table Pneumatic Press	1
1.2	Safety Tips	2
<b>2.</b>	<b>Installation</b>	<b>3</b>
2.1	Transport Instructions	3
2.2	Installing the Machine	3
2.3	Electrical Requirements	3
2.4	Pneumatic Requirements	4
2.5	Adjusting the Pressure	4
<b>3.</b>	<b>How to operate the Studio Twin Table Pneumatic Press</b>	<b>6</b>
3.1	Starting with the Studio Twin Table Pneumatic Press	6
3.2	Working with Heat Transfer Materials	6
3.3	Pressing Pad Assembly	7
3.4	Shutting Down the Machine	7
<b>4.</b>	<b>Maintenance of the Machine</b>	<b>8</b>
4.1	Daily Maintenance	8
4.2	Periodic Maintenance	8
4.3	Cleaning	8
<b>5.</b>	<b>Machine Drawings and Diagrams</b>	<b>9</b>
5.1	General Layout	10
5.2	Exploded Diagram and Parts List	11
5.3	Control Unit Operation	12
5.4	Electrical Diagram	13
5.5	Pneumatic Schematic	14
<b>6.</b>	<b>Design Change</b>	<b>15</b>
<b>7.</b>	<b>Guarantee (Limited Warranty)</b>	<b>16</b>
	<b>Declaration of Conformity</b>	<b>17</b>

---

# 1. Introduction Studio Twin Table Pneumatic Press

---

## 1.1 Specifications of the Studio Twin Table Pneumatic Press

---

The Studio Twin Table Pneumatic Press is a manually operated heat press for transfer printing and material fusing. It is ideal for medium to high volume production.

**The work area is:**

**Studio Twin Table Pneumatic Press** 38 x 50 cm (*15 x 19.7 in*)

### Specifications:

Power consumption	2.5 kW
Power supply	230 Volts AC
Max. working temperature	230°C ( <i>446°F</i> )
Display Timer Range	0 – 999 sec
Machine height	55 cm ( <i>21.7 in</i> )
Machine width	113 cm ( <i>44.5 in</i> )
Machine depth	62 cm ( <i>24.5 in</i> )
Machine working area	55(H) x 91.5(W) x 67(D) cm ( <i>21.7(H) x 36(W) x 26.40(D) in</i> )
Size Export Packed	59(H) x 117(W) x 77(D) cm ( <i>23(H) x 46(W) x 30(D) in</i> )
Net weight	95 Kg ( <i>209.4 lbs</i> )
Weight Export Packed	105 Kg ( <i>231.5 lbs</i> )
Press pad dimensions	38 x 50 cm ( <i>15 x 19.7 in</i> )
Mains Fuse	12 A
Auxiliary Fuse	3.15 A

## 1.2 Safety Tips

---

- ◆ **If required, our customer service team** can arrange maintenance service.
  - ◆ **The Studio Twin Table Pneumatic Press** meets the European Legislation standard. Under normal conditions accidents are rare. However listed below are some practical points to ensure your safety.
    - **Always use both hands** when operating the cycle start buttons.
    - **Always switch off** the current (and pull plug out of the socket) when undertaking maintenance work or when cleaning the machine.
    - **Ensure that there is** sufficient space around the machine and adequate clearance for the machine to slide from side-to-side. Cables and connections must not get jammed. Although the heat radiation of the press is low, there should be enough space for cooling down.
    - **Avoid contact** with the heat plate.
  - ◆ **DO NOT REMOVE THE CONTROLLER UNLESS QUALIFIED TO DO SO** - touching internal parts is dangerous and may cause shock hazard. All electrical connections inside covers are live. Never operate Press with any covers and/or guards removed.
  - ◆ **PROTECT THE MAINS CABLE** - damage to the mains cable may cause fire or shock hazard. When unplugging, hold by the plug only and remove carefully. Take care that the mains cable does not come into contact with the heat plate (or moving parts of the mechanism) during operation of the machine.
  - ◆ **OPERATING AMBIENT TEMPERATURE RANGE** - the operating ambient temperature range is 32°F - 104°F, (0°C - 35°C) and humidity of 20% - 80%.
  - ◆ **MACHINE FUSES** - MAINS FUSE TYPE: ultra-rapid (FF) fuse 1¼" 240 Vac max. 12 Amps, AUXILIARY FUSE TYPE: ultra-rapid (FF) fuse 1¼" 240 Vac max. 3.15 Amps.
  - ◆ **WARNING - THIS APPARATUS MUST BE EARTHED (GROUNDED)**
  - ◆ **CAUTION**  
This machine gets hot whilst operating. Take care not to touch any surfaces that are labelled "Caution this plate is HOT".
  - ◆ **MACHINE OPERATION**  
Only persons trained to do so should operate this machine.
-

## 2. Installation

---

### 2.1 Transport instructions

---

**The machine comes to you** either shrink-wrapped or in a box. If you have to transport the machine at any time it is recommended that you use a similar box and packing method. Please let the machine cool down before packing.

### 2.2 Installing the machine

---

- 2.2.1 **Remove all** packaging from the heat press.
- 2.2.2 **Care must be taken** when lifting the machine from the box, as the head is liable to move and may cause personal injury.
- 2.2.3 **Check to ensure** that no damage has been caused to the machine during transit.
- 2.2.4 **Place the machine** on a sturdy level and horizontal surface that is within easy reach of the operator and allow space for the head/plate to slide from side-to-side. Ensure that no items vulnerable to heat radiation are too close to the machine.
- 2.2.5 **Fit Cylinder Head Cover** into place by sliding over the head screws. **Then fully tighten.**

### 2.3 Electrical requirements

---

**The Studio Twin Table Pneumatic Press should** be connected to the mains supply, by the mains cable provided and a suitable plug.

**The press is designed** for 230 VAC 50/60 hertz and requires exclusive use of a power outlet rated for at least 15 Amps.

**Ensure that** the supply rating on the machine specification plate corresponds with your local supply and that the correct plug is fitted.

#### **MAINS LEAD**

**The wires** in this mains lead are coloured in accordance with the following code:

<b>Green and Yellow:</b>	<b>EARTH</b>
<b>Blue:</b>	<b>NEUTRAL</b>
<b>Brown:</b>	<b>LIVE</b>

**As the colours** of the wires in the mains lead of this apparatus may not correspond with the coloured markings identifying the terminals in your plug, proceed as follows:-

---

## Electrical requirements (cont.)

---

1. **The wire coloured green and yellow** must be connected to the terminal in the plug that is marked by the letter E, or by the safety earth symbol coloured green, or green and yellow.
2. **The wire coloured blue** must be connected to the terminal, which is marked with the letter N.
3. **The wire coloured brown** must be connected to the terminal, which is marked with the letter L.

### NOTE:

**Replacement of the mains cable** must be done by a competent service engineer.

### HEATING ELEMENT

**The heating element** fitted to the **Studio Twin Table Pneumatic Press** is rated at 2.5 kW.

**Never connect** to any outlet or power supply having a different voltage/frequency from that on the machine data plate.

## 2.4 Pneumatic requirements

---

**The Studio Twin Table Pneumatic Press** should be connected through a filter regulator to a compressed air supply capable of delivering 60 litres/min at a pressure of 3.5 - 7 bar max. (*2 cu.ft/min at 50-100 psi*). The press will not operate if the pressure drops below 3.5 bar. (*40 psi*). Double hose clips should be used on the delivery hose.

We would advise that when setting up the machine you check that sufficient pressure is maintained into the rear regulator valve. When the desired pressure is achieved the regulator is locked by pushing the knob back down. We recommend that this should be set between 4 to 6 Bar.

The Pressure Adjustment Gauge on the Filter/Pressure Regulator should only be used to control the settings required for heat transfer and garments.

## 2.5 Adjusting the pressure

---

**This press is fitted** with a manually adjustable pneumatic pressure regulator on the Filter/Pressure Regulator. To adjust the operating air pressure, and therefore the pressure exerted by the press on the work, the regulator is unlocked by pulling upward the black plastic knob. Turning the regulator knob clockwise will increase the air pressure; turning anticlockwise will decrease the pressure. When the desired pressure is achieved the regulator is locked by pushing the knob back down.

## **Adjusting the pressure (cont.)**

---

### **NOTE**

**DO NOT** adjust the pressure when the machine is clamped shut

### **CAUTION**

**This machine is designed to be used with a light to medium clamping pressure. If the pressure of the machine is adjusted too high this may cause damage to the machine and invalidate your warranty. Other machines are available for high-pressure applications. Please ask your supplier for details.**



## 3. How to Operate the Studio Twin Table Pneumatic Press

---

### 3.1 Starting with the Studio Twin Table Pneumatic Press

---

**3.1.1 Ensure machine is connected** to a suitable air supply.

**3.1.2 Plug into your supply** outlet and switch supply on.

**N.B.** Please ensure the mains plug is easily accessible to the operator so that in the event of a fault the machine can be unplugged.

**3.1.3 Turn on the Studio Twin Pneumatic Press;** the on/off switch is on the back of the machine. Set the machine controls as necessary. See instructions for adjusting the pressure, **page 4** and operation of Control Units **page 12**. Press red on/off button to activate the power to heat the Heat Plate.

### 3.2 Working with Heat Transfer Materials

---

**Always ascertain** from the supplier of material and transfer paper, that the material to be used is suitable for, and has been prepared for transfer printing.

**3.2.1 Ensure that** the heat controller is set to the correct setting for the material being used. Before using the machine, preheat the base pad of the machine by closing and re-opening the press a number of times.

**After pre-heating** ensure that the machine is in the fully open position.

**3.2.2 Place the article** to be transfer printed onto the pressing pad and locate the transfer paper/substrate material on top in the position required. **Take care not to touch the heat plate to avoid the risk of a burn.**  
**Lower the heat plate** by pressing both Cycle Start Buttons simultaneously.

**NB.** During the application dwell time the other table can be prepared for loading.

**3.2.3 When the required time** interval has elapsed the press will open automatically.

**3.2.4 Unload the garment from the table** of the machine taking care not to touch the heat plate to avoid risk of a burn, slide the heat plate across to the other table and repeat.

---

### 3.3 Pressing Pad Assembly

---

**The pressing pads** normally supplied with this machine are silicone rubber. The pressing pad must be maintained in good condition at all times and replaced when showing signs of wear. A worn pressing pad will always affect the quality of printing/fusing. Do not insert items into the machine, which would tend to cut the pressing pad, i.e. buttons, pins, press-studs or zips.

**Never allow** the hot heat plate to rest on the pressing pad when the press is not being used as the pad may be damaged.

#### **IMPORTANT NOTE:**

**The pressing pads** supplied with the machine are of the correct thickness. Using a thicker pad may invalidate your warranty.

### 3.4 Shutting Down the Machine

---

**To shut down the machine**, turn off the on/off switch at the back of the machine.

## 4. Maintenance of the Machine

---

### 4.1 Daily Maintenance

---

**For good press results** it is important to keep the press surfaces clean. Wipe the surface of the heat plate with a dry cloth before use when the plate is cold.

### 4.2 Periodic Maintenance

---

**Put a few drops of oil** onto the various pivot pins and the pressure adjusting screw every three months.

### 4.3 Cleaning

---

**Clean the outside** of the machine frequently with a clean, moist cloth. This may conveniently be carried out before starting when the machine is cool. First unplug the machine!

## **5. Machine Drawings and Diagrams**

---

**On the following pages** are the schematic diagrams for the Studio Twin Table Pneumatic Press.

<b>5.1</b>	<b>General Layout.....</b>	<b>Page 10</b>
<b>5.2</b>	<b>Exploded diagram and parts list.....</b>	<b>Page 11</b>
<b>5.3</b>	<b>Control Unit operation.....</b>	<b>Page 12</b>
<b>5.4</b>	<b>Electrical Diagram.....</b>	<b>Page 13</b>
<b>5.5</b>	<b>Pneumatic Schematic.....</b>	<b>Page 14</b>

## 5.1 Machine General Layout

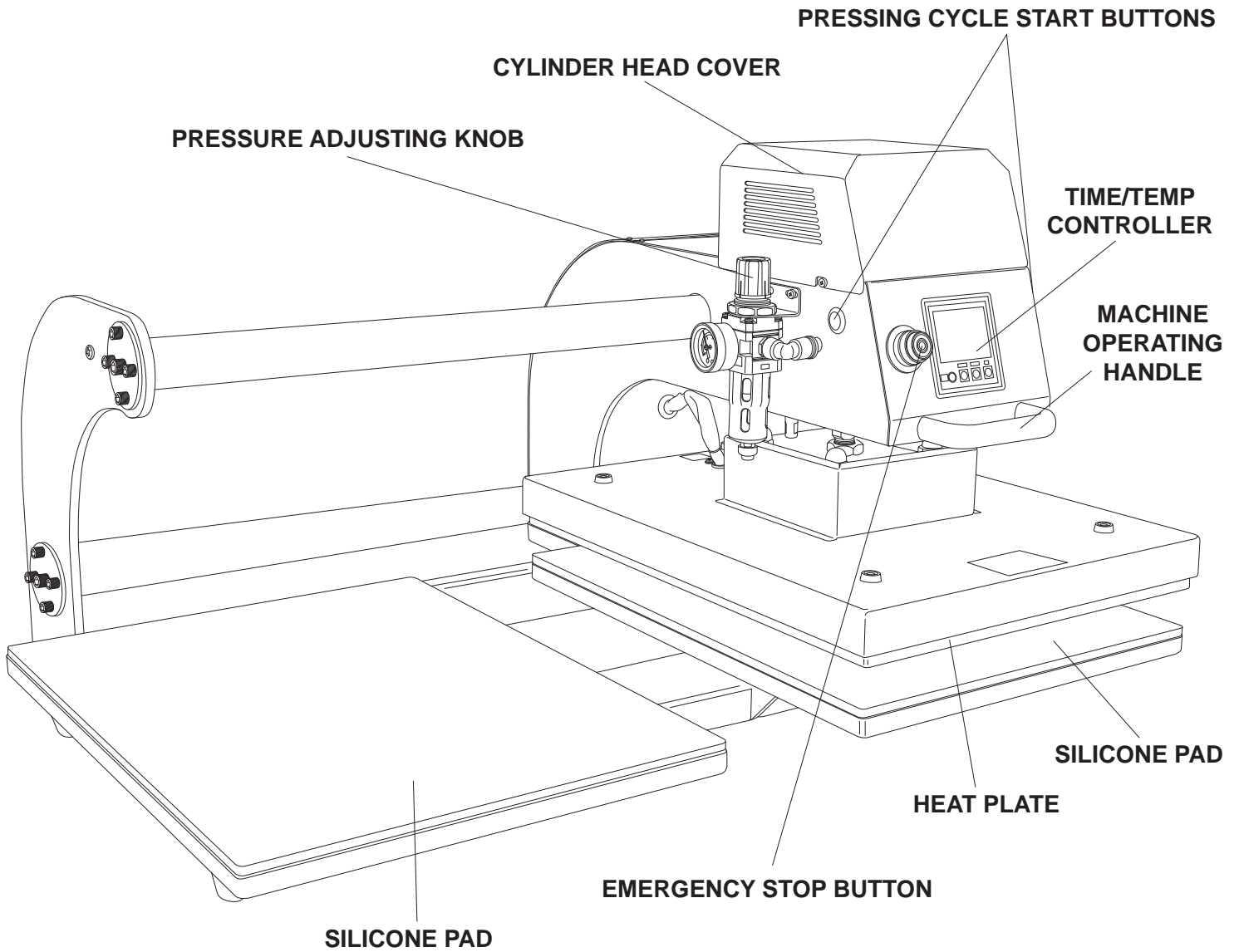

## 5.2 Exploded Diagram and Parts List

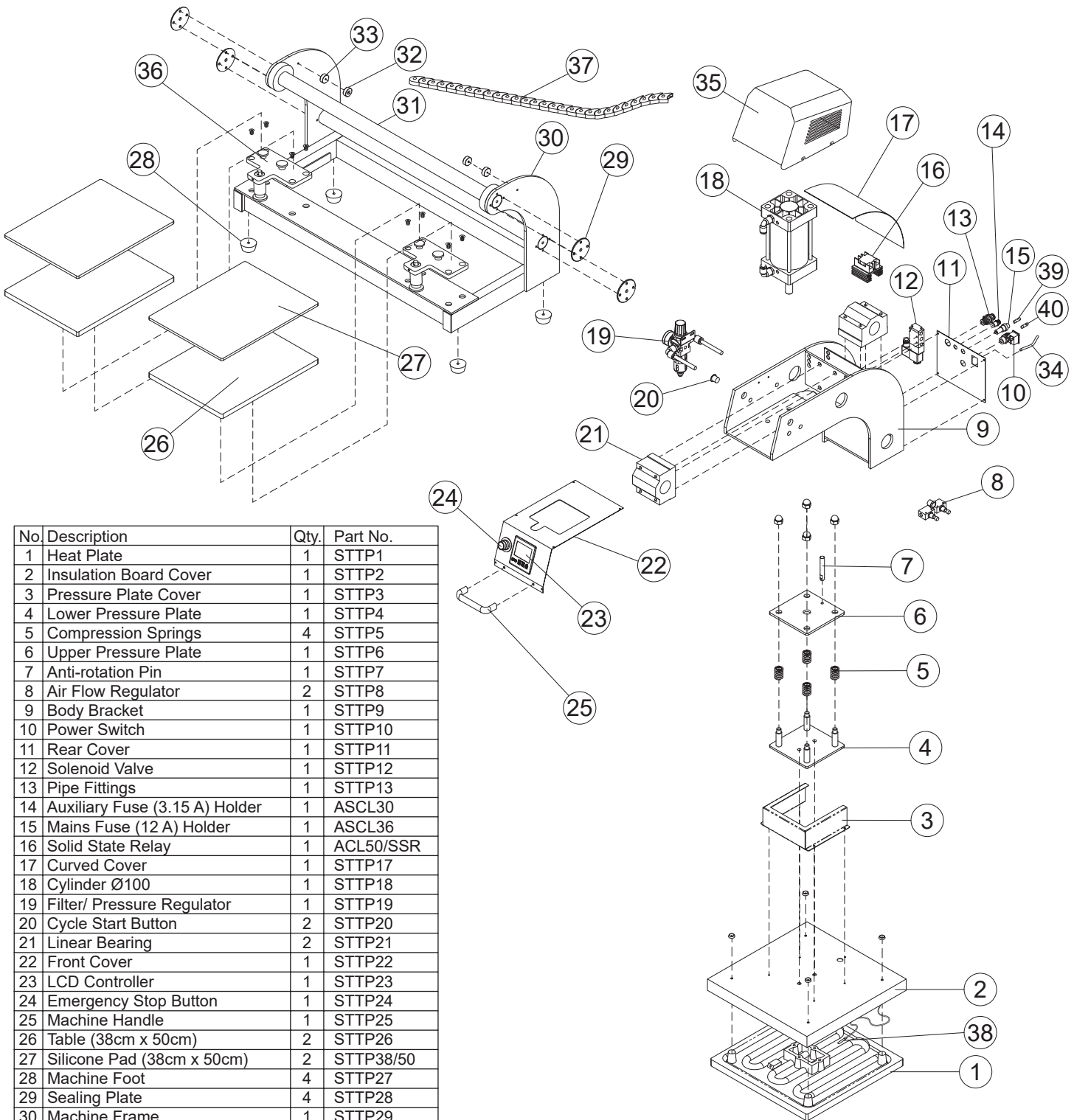

No	Description	Qty.	Part No.
1	Heat Plate	1	STTP1
2	Insulation Board Cover	1	STTP2
3	Pressure Plate Cover	1	STTP3
4	Lower Pressure Plate	1	STTP4
5	Compression Springs	4	STTP5
6	Upper Pressure Plate	1	STTP6
7	Anti-rotation Pin	1	STTP7
8	Air Flow Regulator	2	STTP8
9	Body Bracket	1	STTP9
10	Power Switch	1	STTP10
11	Rear Cover	1	STTP11
12	Solenoid Valve	1	STTP12
13	Pipe Fittings	1	STTP13
14	Auxiliary Fuse (3.15 A) Holder	1	ASCL30
15	Mains Fuse (12 A) Holder	1	ASCL36
16	Solid State Relay	1	ACL50/SSR
17	Curved Cover	1	STTP17
18	Cylinder Ø100	1	STTP18
19	Filter/ Pressure Regulator	1	STTP19
20	Cycle Start Button	2	STTP20
21	Linear Bearing	2	STTP21
22	Front Cover	1	STTP22
23	LCD Controller	1	STTP23
24	Emergency Stop Button	1	STTP24
25	Machine Handle	1	STTP25
26	Table (38cm x 50cm)	2	STTP26
27	Silicone Pad (38cm x 50cm)	2	STTP38/50
28	Machine Foot	4	STTP27
29	Sealing Plate	4	STTP28
30	Machine Frame	1	STTP29
31	Chrome Glide Arm	2	STTP30
32	Magnet	2	STTP31
33	Pad Washer	2	STTP32
34	Mains Lead	1	STTP33
35	Cylinder Head Cover	1	STTP34
36	Table Quick Release Mechanism	2	STTP35
37	Flexible Armoured Cable Conduit	1	STTP36
38	Probe (Extra Long)	1	ASCL27L
39	Fuse 3.15 A	1	ASCL30/A
40	Fuse 15 A	1	ASCL37

## 5.3 Operation Of Control Unit, Setting Time and Temperature

(The head must always be in the up position before the controller is set)

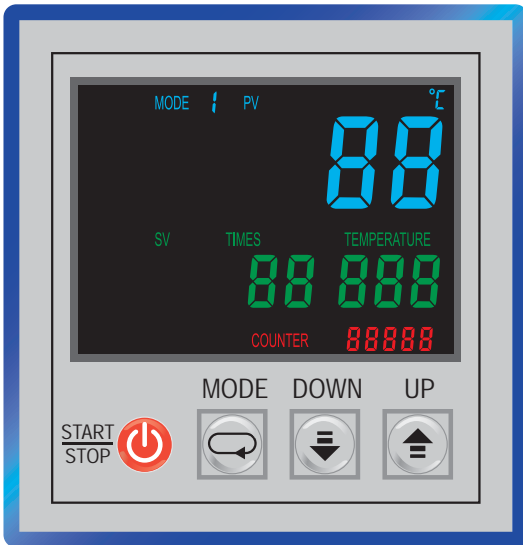

### Setting Time

1. Switch on machine.
2. Press and hold the 'MODE' button for approximately 3 seconds, until an audible bleep is heard, then release ('SV' and 'TIMES' indicators will now flash).
3. Press the '▲' button or the '▼' button to change the digit (between 1 and 9). Repeat this procedure for the remaining two digits, or until the desired time is reached.
4. When the required time is reached press the 'MODE' button for approximately 3 seconds, until an audible bleep is heard, then release, the time is then set.

### Setting Temperature

1. Switch on machine.
2. Press and hold the 'MODE' button for approximately 3 seconds, until an audible bleep is heard, then release.
3. Press 'MODE' button for approximately 3 seconds, until an audible bleep is heard, then release ('SV' and 'TEMPERATURE' indicators will now flash).
4. Press the '▲' button or the '▼' button to change the digit (between 1 and 9). Repeat this procedure for the remaining two digits, or until the desired temperature is reached.
5. When the required temperature is reached press 'MODE' button for approximately 3 seconds, until an audible bleep is heard, then release, the temperature is then set.

### Resetting Counter

1. Switch on machine.
2. Press and hold the 'MODE' button for approximately 3 seconds, until an audible bleep is heard, then release.
3. Press 'MODE' button twice ('SV' and 'COUNTER' indicators will now flash).
4. Press the '▼' arrow button to clear.
5. Press the 'MODE' button for approximately 3 seconds, until an audible bleep is heard, then release, to return to normal setting.

### Note:

When the Time, Temperature or Counter are changed and the Controller display is reset 'rE' will be displayed on the Controller screen. When the machine is next operated this will disappear and 'TIME' and 'TEMPERATURE' will be displayed as normal.

## 5.4 Electrical Diagram

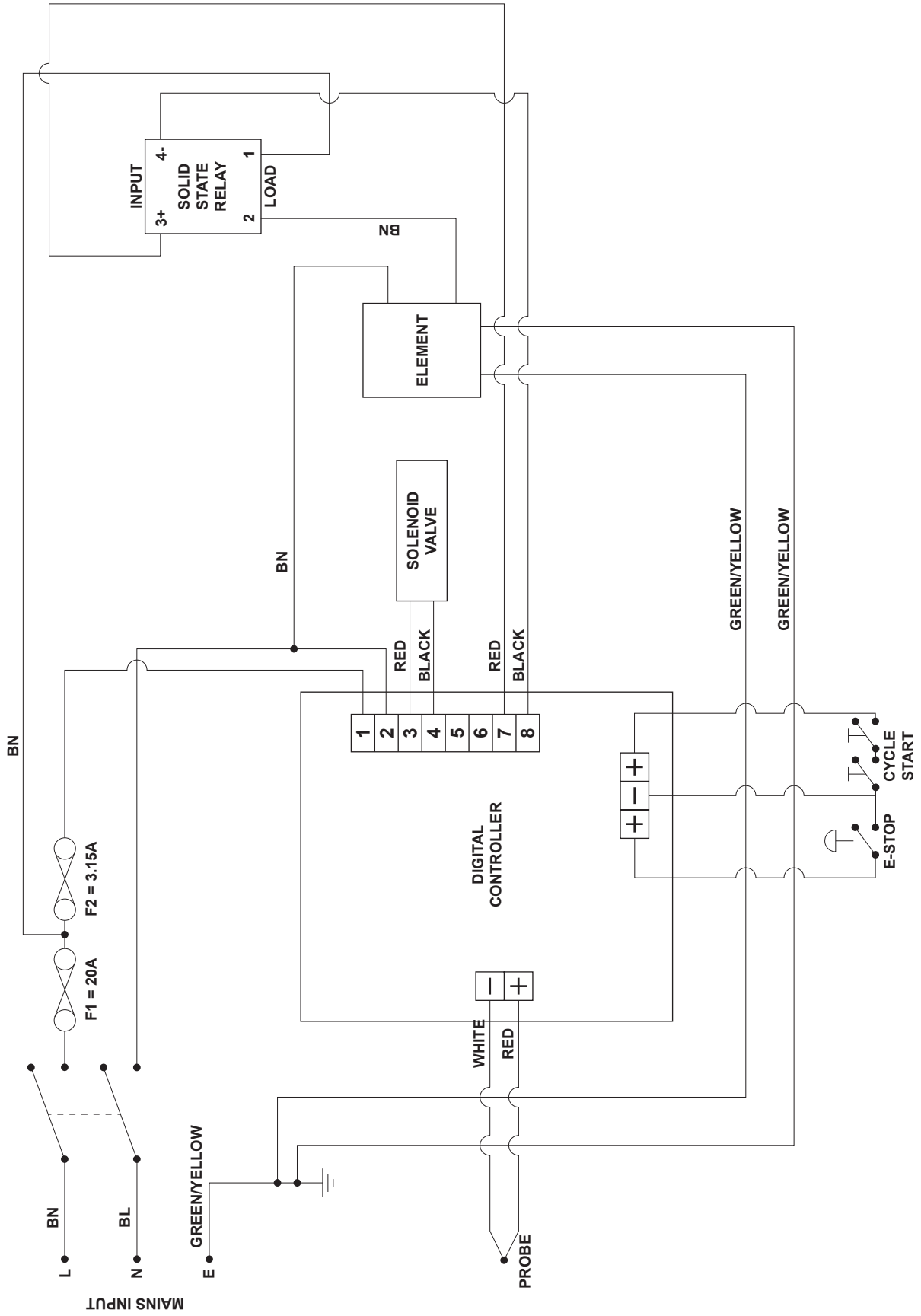



## 5.5 Pneumatic Schematic

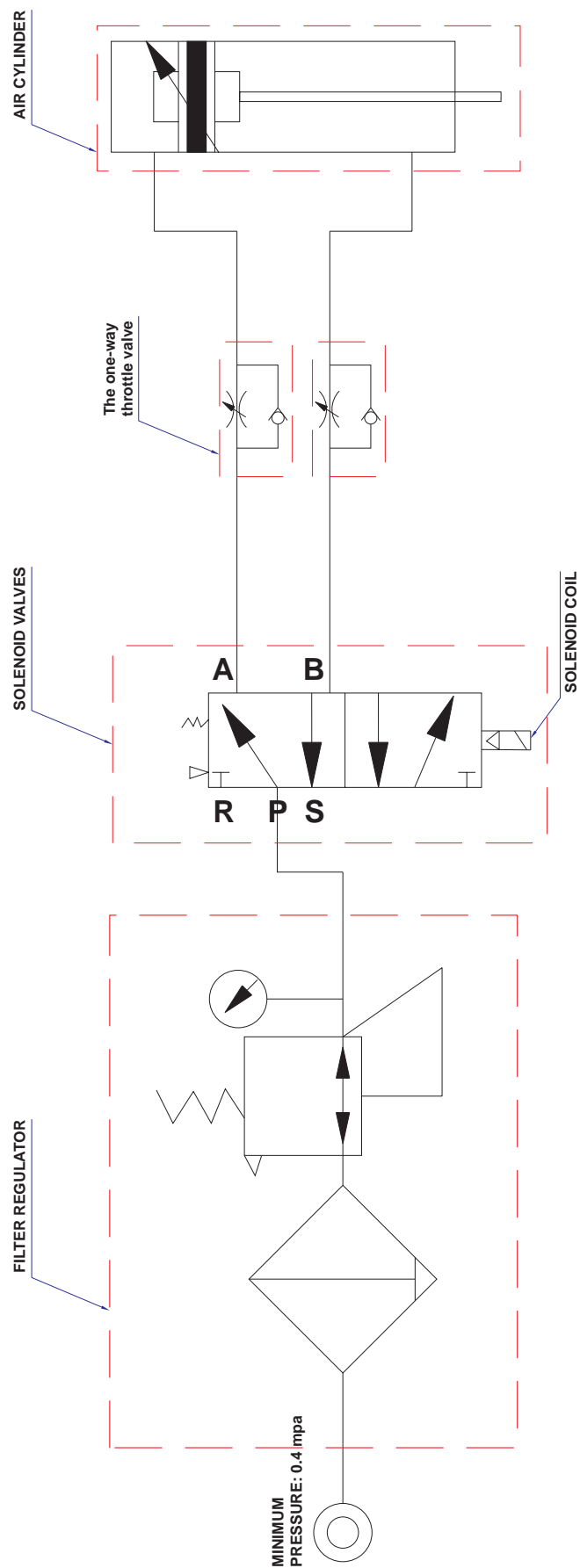

## 6. Design Change

---

**With the policy of constant improvement** and/or modification to meet changing conditions, the right is reserved to change the design and/or specifications at any time without prior notification, and therefore specifications may vary and not be in accordance with this manual.

## 7. Guarantee (Limited Warranty)

---

**A. Adkins & Sons Limited** warrants that the press is free from defects in material and workmanship for a period of 12 months from the date of supply to the customer. The machine comes with a one-year warranty on parts and 90 days labour.

**This warranty covers** all parts to repair the defects, except when damage results from misuse or abuse, accident, alteration or negligence or when a machine has been improperly installed.

**If a press covered by warranty** should need to be returned to the factory for examination and repair, if on-site component replacement is not possible, A. Adkins & Sons Limited will make every effort to repair the customers press. The warranty will only be effective when A. Adkins & Sons Limited authorises the original purchaser to return the machine to the factory and only when the product upon examination has proven to be defective.

**Should in our opinion** any part of this press be defective in materials or workmanship, it will be replaced or repaired free of charge, provided that the press has been installed and operated in the correct manner and not subjected to misuse. If A. Adkins & Sons Limited authorise a replacement press, the warranty of the replacement press shall expire on the anniversary date of the original machines invoice to the customer.

**In order for this warranty to be effective**, no return of machine or parts may be made without prior factory authorisation. (This will exclude any travelling and/or carriage costs which will be charged at our discretion).

**This is the sole warranty given by the company**; there are no warranties, which extend beyond the description on the face hereof. The seller disclaims any implied warranty of merchantability and/or any implied warranty of fitness for a particular purpose; the buyer agrees that the goods are sold "as is". A. Adkins & Sons Limited does not warrant that the functions of the press will meet the customer's requirements or expectations. The entire risk as to use, quality and performance of the press lies with the customer. (No claim of any kind shall be greater than the sale price of the product or part to which the claim is made).

**In no event will A. Adkins & Sons Limited** be liable for any injury, loss or damage, including loss of profits, destruction of goods or any special, incidental, consequential or indirect damages arising from the use of the press or accompanying materials. This limitation will apply even if A. Adkins & Sons Limited or its authorised agent had been advised of the possibility of such damage.

**A. ADKINS & SONS LIMITED**  
**DECLARATION OF CONFORMITY**



<p>Application of Council Directives:</p> <p>Standards to which Conformity is Declared:</p> <p>Manufacturer's Name:</p> <p>Manufacturer's Address:</p> <p>Type of Equipment:</p> <p>Standards Compliance:</p> <p>Model Number:</p> <p>Serial Number:</p> <p>Year of Manufacture:</p>	<p>Machinery, Low Voltage. E.M.C.</p> <p><b><u>BS EN ISO 12100:2010</u></b> - Safety of machinery: Basic Technology, Principles of Design.  <b><u>BS EN 60204-1:2006+A1:2009</u></b> - Safety of machinery: Electrical Equipment of Machines  <b><u>BS EN 60529:1992-A2:2013</u></b> - Degree of protection provided by enclosures.  <b><u>BS EN ISO 13850:2015</u></b> - Safety of Machinery: Emergency Stops.  <b><u>BS EN ISO 141211:2007</u></b> - Safety of Machinery: Principles for Risk Assessment.  <b><u>BS EN 55011:2016+A1:2017</u></b> - Class A Group 2 Equipment - EMC Emissions.  <b><u>BS EN ISO 61000-6-4:2007+A1:2011</u></b> - EMC Conducted Emissions.  <b><u>BS EN ISO 61000-6-2:2005</u></b> - EMC Immunity.  <b><u>Low Voltage Directive 2014/35/EC</u></b> - Including DIN EN 61557-1, -4 and -5.  <b><u>Electro Magnetic Interference Directive 2014/30/EC</u></b> - Including DIN EN 61000-6 series of standards.</p> <p><b><u>A. Adkins &amp; Sons Limited</u></b></p> <p>High Cross, 18 Lancaster Road,  Hinckley, Leicester, LE10 0AW, United Kingdom.</p> <p>Studio Twin Table Pneumatic Heat Press</p>  <p>.....</p> <p>.....</p> <p>.....</p>
--	---

I, the undersigned, hereby declare that the equipment specified above conforms to the above directives and standards.

Place: Hinckley, United Kingdom

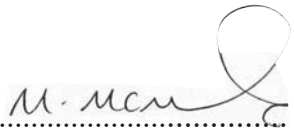
Signature: 

Date: .....

Full Name: Marie McMahon  
Position: General Manager