

**ADKINS**

**ADKINS**  
HEAT PRESS TECHNOLOGY

## STUDIO TWIN MUG



# Operators Handbook

Rev F - 29/03/22

All products within the ADKINS range are labelled with CE marking and are manufactured and tested to comply with EC safety regulations.

# Preface

---

Dear User

**Welcome to the growing group** of Studio Twin Mug Press users. The product you have purchased has been carefully designed and manufactured to ensure that you, the user, will gain the maximum benefit.

**All A. Adkins & Sons Limited products** are specifically designed to ensure ease of use with particular attention to safety requirements.

**Should you discover any fault** or damage upon receipt of this product, you should immediately contact your supplier.

---

# Contents

---

<b>1.</b>	<b>Introduction Studio Twin Mug Press</b>	<b>1</b>
1.1	Specifications of the Studio Twin Mug Press	2
1.2	Safety	3
<b>2.</b>	<b>Installation</b>	<b>5</b>
2.1	Transport instructions	5
2.2	Installing the machine	5
2.3	Electrical requirements	5
2.4	Adjusting the pressure	6
<b>3.</b>	<b>How to operate the Studio Twin Mug Press</b>	<b>7</b>
3.1	Starting with the Studio Twin Mug Press	7
3.2	Working with heat transfer materials	7
3.3	Studio Twin Mug Press Operating Recommendations	8
3.4	Removal & refitting of Element in Studio Twin Mug Press	9
3.5	Heater Band Assembly	9
3.6	Element temperature measurement	10
<b>4.</b>	<b>Maintenance of the Machine</b>	<b>11</b>
4.1	Periodic Maintenance	11
4.2	Cleaning	11
4.3	General Maintenance	11
<b>5.</b>	<b>Machine Drawings and Diagrams</b>	<b>12</b>
5.1	General Layout	13
5.2	Operation of the Control Unit	14
5.3	Exploded Diagram and Parts List	15
5.4	Electrical Diagram	16
<b>6.</b>	<b>Design Change</b>	<b>17</b>
<b>7.</b>	<b>Guarantee (Limited Warranty)</b>	<b>18</b>
	<b>Declaration of Conformity</b>	<b>19</b>

---

# 1. Introduction Studio Twin Mug Press

---

**The Studio Twin Mug Press** has been produced specifically for transfer print decoration of "whiteware" porcelain mugs, dye sub coated. Mugs to be printed must be cylindrical; the supplied wrap around heating elements will accommodate a  $\text{\O}-80$  mm ( $\text{\O}-3.14$  in) large standard mug and optionally (at extra cost) the machine will also accommodate a  $\text{\O}-72$  mm ( $\text{\O}-2.83$  in) small standard mug and smug mug elements.

**This simple robust machine** is powered by two microprocessor digital controllers housed in one single unit for control of both heat and dwell accuracy and ease of operation, requiring minimal operating space.

**The Studio Twin Mug Press** is produced in one version, nominally 230 Volts AC for the European market.

## 1.1 Specifications of the Studio Twin Mug Press

---

**The Studio Twin Mug Press is a manually operated** heat press for transfer printing. It is ideal for medium to high volume production.

**The supplied wrap around heating elements** will accommodate a  $\varnothing$ -80 mm ( $\varnothing$ -3.14 in) large standard mug and optionally (at extra cost) the machine will also accommodate a  $\varnothing$ -72 mm ( $\varnothing$ -2.83 in) small standard mug and smug mug elements.

<b><u>Specifications</u></b>	<b><u>European Machine</u></b>
Power consumption	280 Watts
Power supply	230 Volts AC
Working temperature	0 - 260°C (32 - 500°C)
Display timer range	0 - 9999 sec
Machine height open	37 cm (14.6 in)
Machine width	31 cm (12 in)
Machine depth	35 cm (13.8 in)
Working area	41(W) x 31(H) x 58(D) cm (16(W) x 12(H) x 22.8(D) in)
Gross weight	14.5 Kg (32 lbs)
Net weight	13.5 Kg (29.8 lbs)
Fuse	3 A
<b><u>Supplied heating elements</u></b>	
Large standard mug elements	$\varnothing$ -80 mm ( $\varnothing$ -3.14 in) mug
<b><u>Optional heating elements</u></b>	
Small standard mug elements	$\varnothing$ -72 mm ( $\varnothing$ -2.83 in) mug
Smug mug elements	-

## 1.2 Safety

---

- ◆ **Our customer service department** has its own service engineers and, if required, maintenance and advice is available.
- ◆ **The Studio Twin Mug Press** meets the European Legislation standard. Under normal conditions accidents are rare. However listed below are some practical points to ensure your safety.
  - **Always switch off** the mains supply (and pull plug out of the socket) when undertaking maintenance work or when cleaning the machine.
  - **Ensure that there is** sufficient space around the machine. Cables and connections must not get jammed. Although the heat radiation of the press is low, there should be enough space for cooling down.
  - **Avoid contact** with the press element.
- ◆ **DO NOT REMOVE THE COVER OR CONTROLLER UNLESS QUALIFIED TO DO SO** - touching internal parts is dangerous and may cause shock hazard. All electrical connections inside covers are live. Never operate Press with any covers and/or guards removed.
- ◆ **PROTECT THE MAINS CABLE** - Damage to the mains cable may cause fire or shock hazard. When unplugging, hold by the plug only and remove carefully. Take care that the mains cable does not come into contact with the heater element (or moving parts of the mechanism) during operation of the machine.
- ◆ **OPERATING AMBIENT TEMPERATURE RANGE** - the operating ambient temperature range is, 0°C - 35°C (32°F - 104°F) and humidity of 20 - 80%.
- ◆ **MACHINE FUSES** - type: 3 Amps
- ◆ **WARNING - THIS APPARATUS MUST BE EARTHED (GROUNDED)**
- ◆ **CAUTION**  
This machine gets hot whilst operating. Take care not to touch any surfaces that are labelled “Caution HOT”. **Keep hands away from heating element**
- ◆ **MACHINE OPERATION**  
Only persons trained to do so should operate this machine.

**This machine is designed to be operated by one operator only.**

---

## Safety (Cont.)

---

- ◆ The press should remain in the unclamped position when not in use. When in use, **NEVER** close the machine into the clamped position without a mug as this will destroy the heating element and negate the warranty.
- ◆ Contact your print media suppliers to ascertain whether fumes are given off during the transfer process and if so what precautions are needed for operator safety. These may include air extraction and/or masks for personnel.

**Please refer to page 13 for an illustration of the Studio Twin Mug Press machine.**

## 2. Installation

---

### 2.1 Transport instructions

---

**The machine comes to you** in a box or shrink-wrapped. If you have to transport the machine at any time it is recommended that you use a similar box and packing methods. Please let the machine cool down and move the handle to the locked position, with a mug clamped in printing position.

### 2.2 Installing the machine

---

- 2.2.1 **Remove all** packaging from the heat press.
- 2.2.2 **Check to ensure** that no damage has been caused to the machine during transit.
- 2.2.3 **Place the machine** on a sturdy horizontal surface that is within easy reach of the operator and allow space for the handle to move to the loading position. Ensure that no items vulnerable to heat radiation are too close to the machine.

### 2.3 Electrical requirements

---

**The Studio Twin Mug Press should** be connected to the mains supply, (nominally 230VAC for the European Market), by the mains cable provided and a suitable plug.

**The press is designed** for 230VAC 50/60 hertz and requires exclusive use of a power outlet rated for at least 3.15Amps (Europe).

**Ensure that** the supply rating on the machine specification plate corresponds with your local supply and that the correct plug is fitted.

#### **Wiring the plug for a 230V AC Machine**

**The wires** in this mains lead are coloured in accordance with the following code:

<b>Green and Yellow:</b>	<b>EARTH</b>
<b>Blue:</b>	<b>NEUTRAL</b>
<b>Brown:</b>	<b>LIVE</b>

**As the colours** of the wires in the mains lead of this apparatus may not correspond with the coloured markings identifying the terminals in your plug, proceed as follows:-



## Electrical requirements (Cont.)

---

1. **The wire coloured green and yellow** must be connected to the terminal in the plug, which is marked by the letter E, or by the safety earth symbol coloured green, or green and yellow.
2. **The wire, coloured blue** must be connected to the terminal which is marked with the letter N, or coloured black.
3. **The wire, coloured brown** must be connected to the terminal which is marked with the letter L, or coloured red.

### **N.B.**

**A competent service engineer must carry out any replacement of the mains cable.**

### **HEATING ELEMENT**

**The heating elements** fitted to this press are rated at 280Watts / 230V AC.

**Never connect** to any outlet or power supply having a different voltage/frequency from that on the machine data plate.

## 2.4 Adjusting the pressure

---

**This press is fitted** with a red or black pressure adjustment knob located on the machine:

- a) **To increase pressure** or to use smaller diameter mugs turn knob clockwise.
- b) **To decrease pressure** or to print onto larger diameter mugs, (within the stated range), turn the adjustment knob anticlockwise.
- c) Be careful when placing mug in press that pressure jaws are not in contact with Mug handle as this may cause damage.

### **NOTE**

**DO NOT adjust the pressure when the machine is clamped shut**

### **CAUTION**

**Never increase the pressure to the extent of requiring undue force to lower the operating handle into the lock position, as this will place excessive stress on the heater band, resulting in damage to the press.**

**Please refer to page 14 showing the operation of the control unit.**

---

## 3. How to Operate the Studio Twin Mug Press

---

### 3.1 Starting with the Studio Twin Mug Press

---

#### 3.1.1 Plug into your supply outlet and switch supply on.

**N.B.** Please ensure the mains plug is easily accessible to the operator so that in the event of a fault the machine can be unplugged.

#### 3.1.2 Turn on the Studio Twin Mug Press; the on/off rocker switch is on the back of the machine cover and illuminates when “on”. Set the machine controls as necessary. See instructions for adjusting the pressure 2.4, and the operation of the time temperature unit 5.2.

### 3.2 Working with Heat Transfer Materials

---

**First ascertain from the supplier** of the mugs that they are suitable for transfer printing and obtain from them and from the transfer supplier the correct heat and time dwell setting for the process. Always check for use. ‘Hot’ or ‘Cold’ peel transfers approximate settings may be as follows:

#### 3.2.1 Adjust the pressure setting of the machine by rotating the adjusting knob situated on the machine. (See exploded diagram in this manual). Clockwise for more pressure, anticlockwise for less pressure. It is always best to find the most suitable opening before using the transfers in production. Adjust the position of the Silicone Heating Element, place transfer and mug into machine, positioning it as required. Make any final adjustments using the pressure setting.

#### 3.2.2 From a cold start-up allow the press to heat up to the desired temperature. Insert a plain mug into the press and close the handle. The mug will absorb a large amount of heat and the temperature will drop, but the element will climb to set temperature within a short time. It is normal for the displayed temperature on the controller to fall by up to 30°C very quickly when a cold mug is placed into the press, however the element is designed to recover up to the set temperature very quickly.

#### 3.2.3 When the temperature indicator on the controller reaches the set value, the machine is ready to print. Remove the plain mug then place the print mug in position in the press. When you are satisfied that the mug is in the correct position, gently close the press with the handle, taking care that the machine jaws do not catch on the mug handle. When the handle is closed the machine will start the pressing cycle. The handle must be in the locked position ensuring that the work is fully clamped.

---

## Working with Heat Transfer Materials (Cont.)

---

- 3.2.4 Mug locating stop.** This is used to position mug inside element
- 3.2.5 To achieve a good transfer result** the transfer paper should be placed in the desired position on the mug, securing in place with heat proof adhesive tape and removing all wrinkles. Ensure there is sufficient pressure on the mug for good results. Set the pressure adjustment so that there is good contact with the mug.
- 3.2.6 When the pre-set dwell time** has been reached, a buzzer will sound. The mug should then be released and the carefully taken out of the pressing pad (**it will be very hot**) and the transfer very carefully removed.
- 3.2.7 Please refer** to transfer printer's instructions, as in some cases it is recommended you place mug in bowl of cold water before removing transfer paper.

## 3.3 Studio Twin Mug Press Operating Recommendations

---

- 3.3.1** This machine has been designed to accommodate a mug of 80mm diameter; anything outside this dimension could affect the performance of the heating element and negate the warranty period.
- 3.3.2** The recommended printing area for a mug of 80mm in diameter is 190mm long and 80mm high.
- 3.3.3** When using small mugs please ensure that the heating element is not trapped near the mug handle and machine jaws.
- 3.3.4** The heating element has a 6 months warranty provided that it has been operated in the correct manner and not subjected to misuse.
- 3.3.5 Pressure:** We recommend using medium pressure settings only. (Check with transfer supplier for advice etc.).
- 3.3.6 Temperature:** We recommend that you check with both the Mug and Transfer supplier to obtain the correct settings.

**It is a simple operation to change the heating element and full instructions are given on page 9.**

### **3.4 Removal & Refitting of Element in Studio Twin Mug Press**

---

- 3.4.1 Ensure the machine is cold, switched off and disconnected from the power supply. Remove the cable protection channel underneath the machine by unscrewing the four small screws.
- 3.4.2 Identify the power cord and connector underneath the machine, release the nut of the connector and separate the two halves of the connector.
- 3.4.3 Very carefully remove the element from the machine by unscrewing the three screws on each side of the jaws.
- 3.4.4 Gently ease out the cable, once clear remove the element by carefully pulling the wiring through the underneath of the machine.
- 3.4.5 Refitting is a direct reversal of removal. When refitting the element gently place the element into the press housing and refit the three screws to each side of the jaws, this will then hold the element in its correct setting.
- 3.4.6 Carefully route the wire through the machine taking care to keep it away from any moving parts.
- 3.4.7 Reconnect the connector by tightening the nut, check that the connection is tight.
- 3.4.8 Refit the cable protection channel underneath the machine with the four small screws.
- 3.4.9 Your Mug press should now be ready for use.

### **3.5 Heater Band Assembly**

---

**The heater band** fitted to this machine is faced with silicone rubber and a piece of P.T.F.E. sheet, to prevent 'strike-through' of surplus ink back onto the heater element. The pressing surface must be maintained in good condition at all times. A worn pressing surface will always affect the quality of printing. Do not insert items into the machine, which could damage the printing surface.

### 3.6 Element temperature measurement

---

**Testing of the element** for temperature consistency or fault condition should only be undertaken after consulting A. Adkins and Sons, and then only using a wired Digital Thermometer (**\*please see note below**).



**\*Please Note:**

**The Digital Thermometer with external probe** is suitable for surface, air and immersion/penetration measurement, which is required for all Adkins heat presses.

**Laser Thermometers only measure air surfaces** which can be misleading due to currents of hot air floating on the surface of the element.

## 4. Maintenance of the Machine

---

### 4.1 Periodic Maintenance

---

**CHECK** that the heating element is clean.

**Put a few drops of oil** onto the various pivot pins and the pressure adjusting screw every three months.

### 4.2 Cleaning

---

**Clean the outside** of the machine frequently with a clean, moist cloth. This may conveniently be carried out before starting when the machine is cool. First unplug the machine.

**CHECK** that the heating element is clean and free to clamp easily during pressing operation.

### 4.3 General Maintenance

---

**The following checks should be carried out at regular intervals by a qualified and competent person:-**

- Electrical connections
- Mechanical moving parts

Any enquiries to: [enquiries@aadkins.com](mailto:enquiries@aadkins.com)

## **5. Machine Drawings and Diagrams**

---

**On the following pages** are the schematic diagrams for the Studio Twin Mug Press.

- 5.1 General Layout.....Page 13**
- 5.2 Operation of Control Unit.....Page 14**
- 5.3 Exploded Diagram and Parts List..... Page 15**
- 5.4 Electrical Diagram..... Page 16**

# 5.1 Machine General Layout

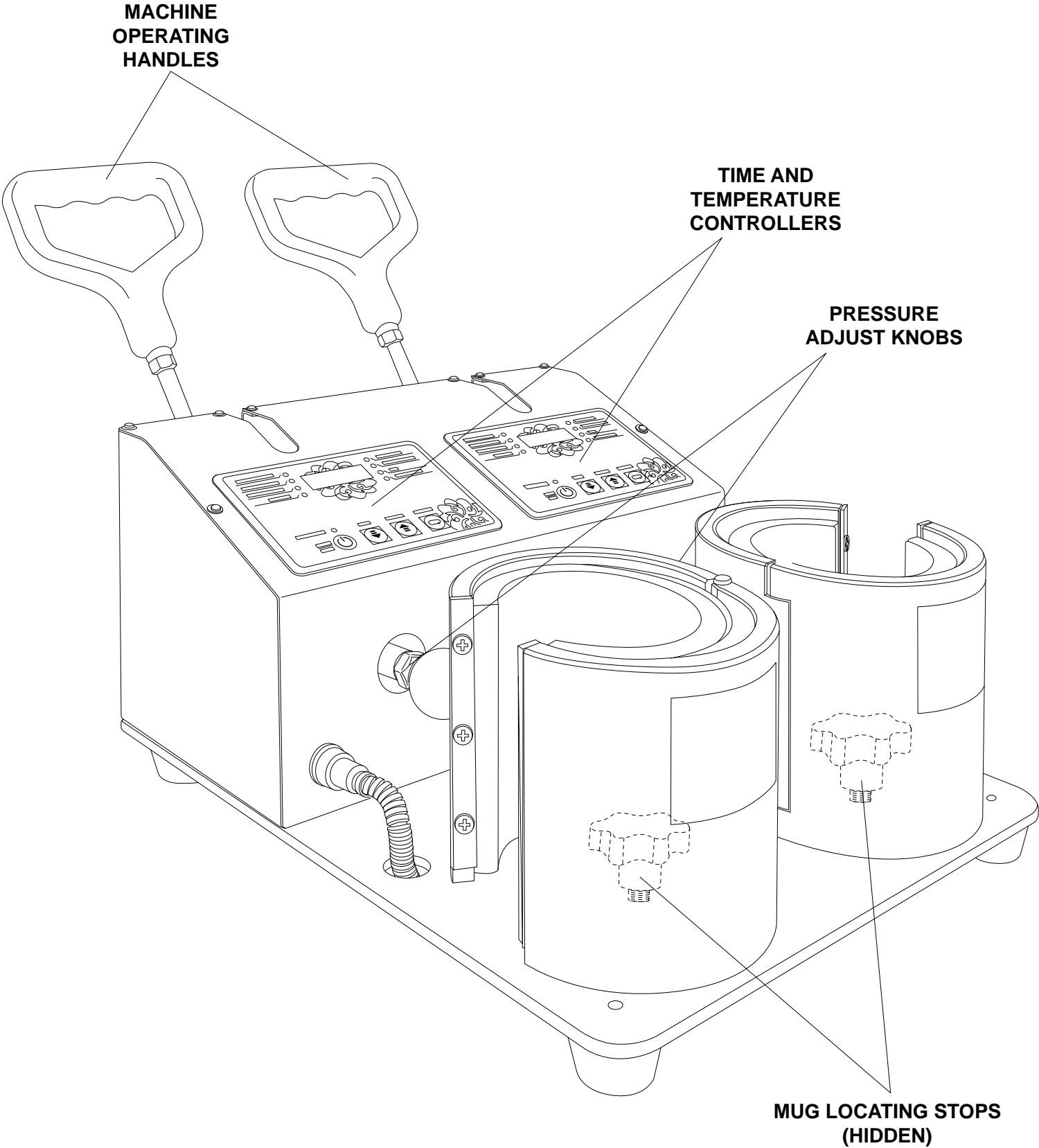



## 5.2 Operation Of Control Unit, Setting Temperature and Time

(The press must always be in the open position before the controller is set)

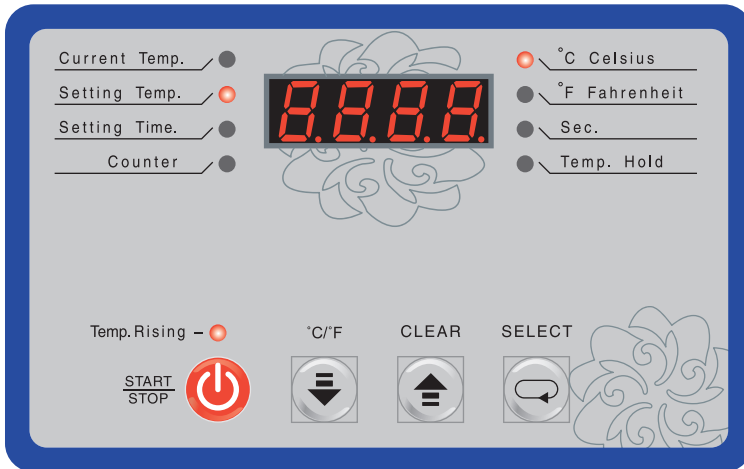

### Setting Temperature

1. Switch on machine.
2. Press 'SELECT' button to select 'Setting Temp' on LH indicator.
3. Use the 'up and down' arrow buttons to set the required temperature.
4. Press 'SELECT' button to select 'Current Temp' on LH indicator.
5. Press 'START/STOP' button to start the machine heating to the selected temperature.

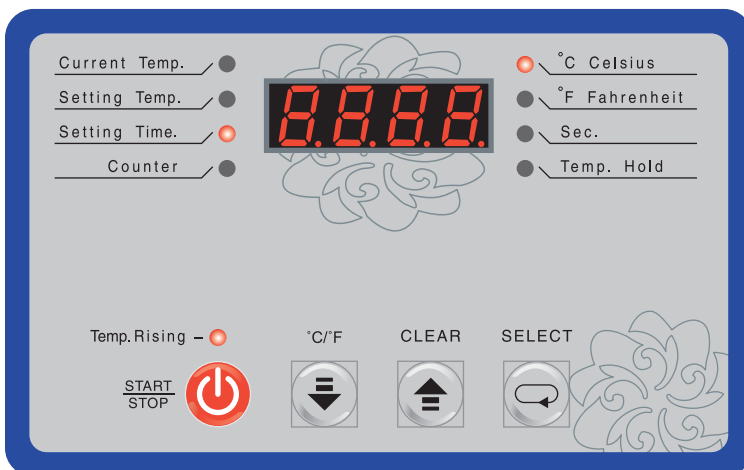

### Setting Time

1. Switch on machine.
2. Press 'SELECT' button twice to select 'Setting Time' on LH indicator.
3. Use the 'up and down' arrow buttons to set the required time.
4. Press 'SELECT' button to select 'Current Temp' on LH indicator.
5. Press 'START/STOP' button to start the machine.

### Selecting Temperature Format

1. Switch on machine.
2. Press and hold '°C/°F' button to select '°C Celsius' or '°F Fahrenheit' on RH indicator.
3. Press and hold '°C/°F' button again to toggle between the two temperature formats.

### Setting Digital Counter to Zero

1. Press 'SELECT' button three times to select 'Counter' on LH indicator.
2. Press and hold 'CLEAR' button to zero counter.

## 5.3 Exploded Diagram and Parts List.

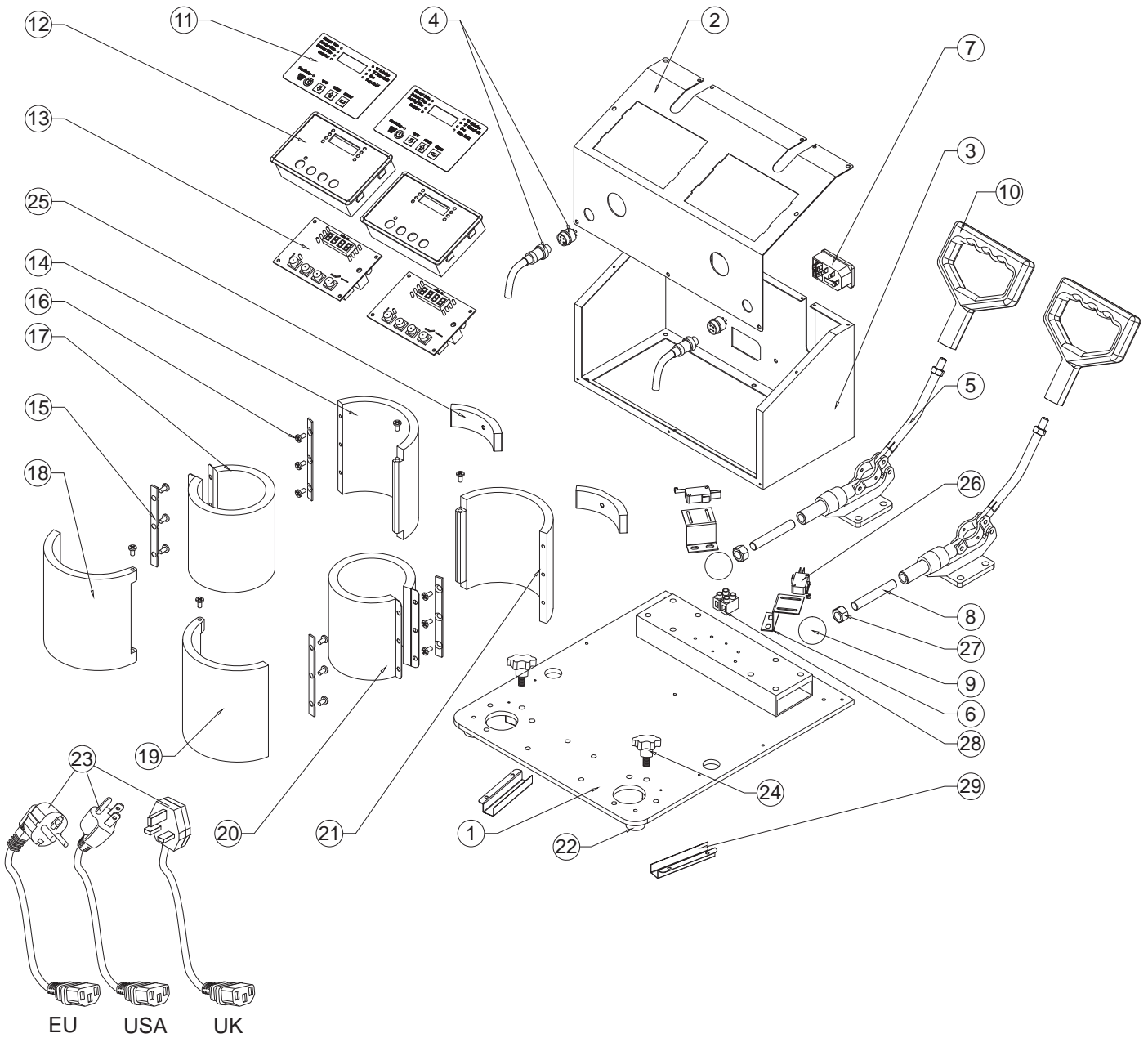

EU      USA      UK

No.	Description	Qty.	Part No.
1	Base Plate	1	ASTM1
2	Cover	1	ASTM2
3	Controller Housing	1	ASTM3
4	Element Plug & Socket Assembly	2	ASTM4
5	Toggle Unit	2	ASM7/TWIN
6	Microswitch Bracket	2	ASM8
7	Socket + 3.15 Amp Fuse	2	ASM13
8	Adjuster Ball Rod	2	ASTM5
9	Pressure Adjuster Ball	2	ASM6
10	Handle	2	ASM11
11	PVC Facia	2	ASTM6
12	Plastic Housing	2	ASM18/N
13	Controller Unit	2	ASM19
14	Movable Jaw LH Rear	1	ASM10
15	Element Retaining Plate	4	ASM5
16	Retaining Plate Screws	22	ASTM10

17	LH Heater/Element Assembly	1	ASTM11
18	Movable Jaw LH Front	1	ASTM12
19	Movable Jaw RH Front	1	ASTM13
20	RH Heater/Element Assembly	1	ASTM14
21	Movable Jaw RH Rear	1	ASTM15
22	Undercarriage Rubber Feet	4	ASTM22
23	Mains Lead and Plug 230 V (UK)	1	BMC618
	Mains Lead and Plug 120 V (USA)	1	BMC618/A
	Mains Lead and Plug 230 V (EU)	1	BMC620
24	Mug Locating Stop	2	ASTM16
25	Pressure Adjusting Block	2	ASTM17
26	Micro Switch	2	AM312
27	M10 Nut	2	M10NUT
28	Connector Block	1	ASTM28
29	Cable Conduit	2	ASTM29

## 5.4 Electrical Diagram

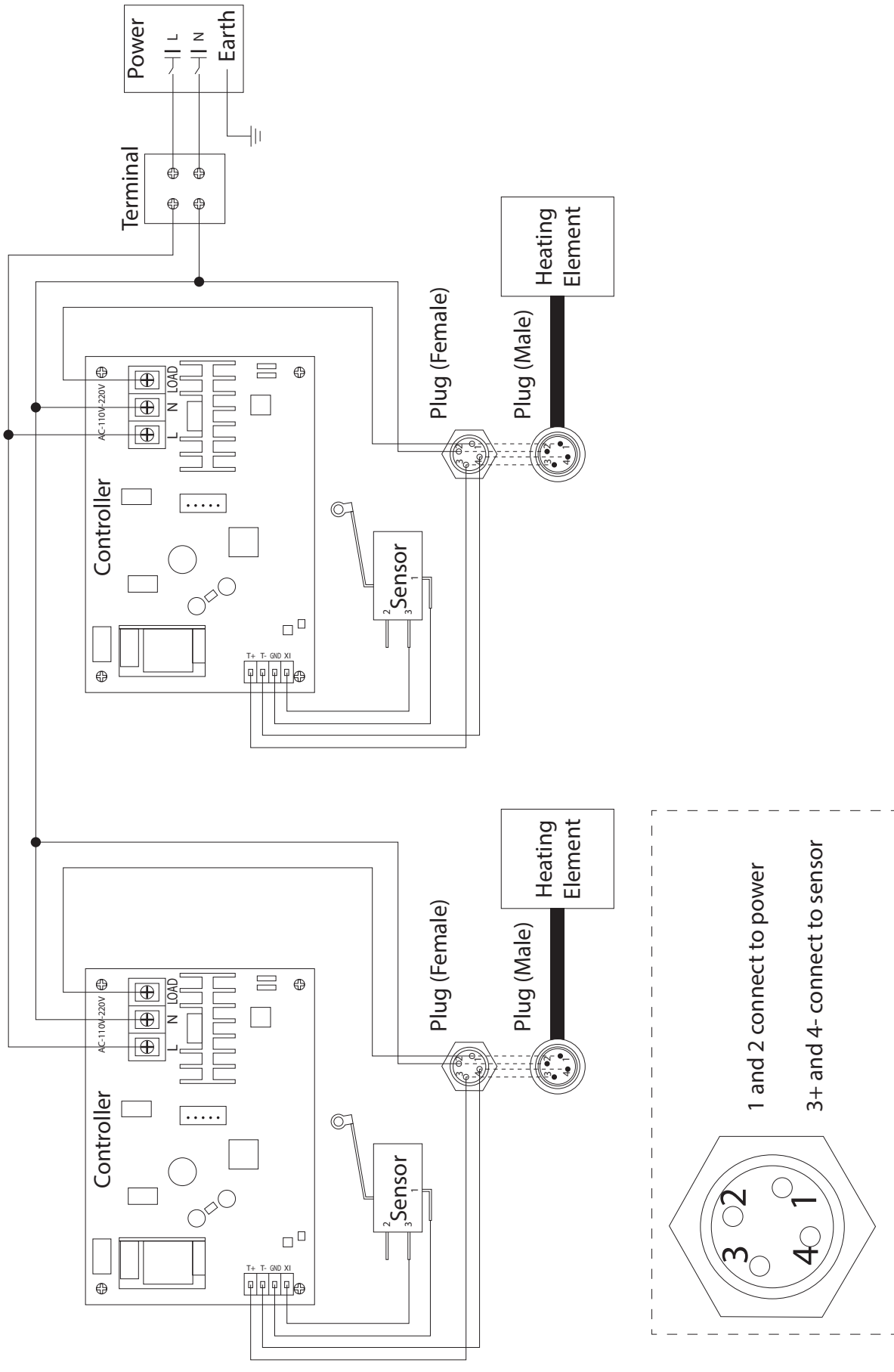

## 6. Design Change

---

**With the policy of constant improvement** and/or modification to meet changing conditions, the right is reserved to change the design and/or specifications at any time without prior notification, and therefore specifications may vary and not be in accordance with this manual.

## 7. Guarantee (Limited Warranty)

---

**A. Adkins & Sons Limited** warrants that the press is free from defects in material and workmanship for a period of 12 months from the date of supply to the customer. The machine comes with a one-year warranty on parts and 90 days labour and a 6 month warranty on heating elements.

**This warranty covers** all parts to repair the defects, except when damage results from misuse or abuse, accident, alteration or negligence or when a machine has been improperly installed.

**If a press covered by warranty** should need to be returned to the factory for examination and repair, if on-site component replacement is not possible, A. Adkins & Sons Limited will make every effort to repair the customers press. The warranty will only be effective when A. Adkins & Sons Limited authorises the original purchaser to return the machine to the factory and only when the product upon examination has proven to be defective.

**Should in our opinion** any part of this press be defective in materials or workmanship, it will be replaced or repaired free of charge, provided that the press has been installed and operated in the correct manner and not subjected to misuse. If A. Adkins & Sons Limited authorise a replacement press, the warranty of the replacement press shall expire on the anniversary date of the original machines invoice to the customer.

**In order for this warranty to be effective**, no return of machine or parts may be made without prior factory authorisation. (This will exclude any travelling and/or carriage costs which will be charged at our discretion).



**This is the sole warranty given by the company**; there are no warranties, which extend beyond the description on the face hereof. The seller disclaims any implied warranty of merchantability and/or any implied warranty of fitness for a particular purpose; the buyer agrees that the goods are sold "as is". A. Adkins & Sons Limited does not warrant that the functions of the press will meet the customer's requirements or expectations. The entire risk as to use, quality and performance of the press lies with the customer. (No claim of any kind shall be greater than the sale price of the product or part to which the claim is made).

**In no event will A. Adkins & Sons Limited** be liable for any injury, loss or damage, including loss of profits, destruction of goods or any special, incidental, consequential or indirect damages arising from the use of the press or accompanying materials. This limitation will apply even if A. Adkins & Sons Limited or its authorised agent had been advised of the possibility of such damage.



HEAT PRESS TECHNOLOGY

# A. ADKINS AND SONS LIMITED DECLARATION OF CONFORMITY

Application of Council Directives:	European Low Voltage Directive ( <b>LVD</b> ), European Machinery Directive ( <b>MD</b> ), Electro Magnetic Conformity ( <b>EMC</b> )
Standards to which Conformity is Declared:	( <b>LVD</b> ): <u>EN 60204-1:2018</u> ( <b>MD</b> ): <u>EN ISO 12100:2010 2006/42/EC Annex1</u> ( <b>EMC</b> ): <u>EN 61000-6-2:2019</u>
Manufacturer's Name:	<u><b>A. Adkins and Sons Limited</b></u>
Manufacturer's Address:	High Cross, 18 Lancaster Road, Hinckley, Leicestershire LE10 0AW United Kingdom.
Type of Equipment:	Studio Twin Mug Heat Press
Standards Compliance:	 
Model Number:	<u>ASTM</u> .....
Serial Number:	.....
Year of Manufacture:	.....

I, the undersigned, hereby declare that the equipment specified above conforms to the above directives and standards.

Place: Hinckley, United Kingdom

Signature: 

Date: .....

Full Name: Marie McMahon

Position: General Manager