

ADKINS

ADKINS
HEAT PRESS TECHNOLOGY

BETA CAP



Operators Handbook

All products within the ADKINS range are labelled with CE marking and are manufactured and tested to comply with EC safety regulations.

Preface

Dear User

Welcome to the growing group of Beta Cap Press users. The product you have purchased has been carefully designed and manufactured to ensure that you, the user, will gain the maximum benefit.

All Charterhouse Holdings PLC products are specifically designed to ensure ease of use with particular attention to safety requirements.

Should you discover any fault or damage upon receipt of this product, you should immediately contact your supplier.

Contents

1.	Introduction Beta Cap Press	1
1.1	What did you receive?	2
1.2	Specifications of the Beta Cap Press	3
1.3	Safety	4
1.4	Safety tips	4
2.	Installation	7
2.1	Transport instructions	7
2.2	Installing the machine	7
2.3	Electrical requirements	7
2.4	Adjusting the pressure	8
2.5	Adjusting the time and temperature	8
3.	How to operate the Beta Cap Press	9
3.1	Starting with the Beta Cap Press	9
3.2	Working with heat transfer materials	9
3.3	Pressing pad assembly	11
3.4	Shutting down the machine	11
3.5	Fault diagnosis	11
3.6	Hints and tips	12
3.7	Heat Plate Temperature Measurement	13
4.	Maintenance of the Machine	14
4.1	Daily maintenance	14
4.2	Periodic maintenance	14
4.3	General Maintenance	14
4.4	Cleaning	14
5.	Machine Drawings and Diagrams	15
5.1	General layout	16
5.2	Control unit operation	17
5.3	Exploded diagram and parts list	18
5.4	Machine - Electrical diagram	19
5.5	Controller - Electrical diagram	20
6.	Design Change	21
7.	Guarantee	22
	Declaration of Conformity	23

1. Introduction Beta Cap Press

The Beta Cap Press is a manually operated heat press for printing caps and similar small items. This simple robust machine is powered by a micro-processor for control of both heat and dwell accuracy and ease of operation and requires minimal operating space.

The work area of the Beta Cap Press is 15 cm x 9.3 cm (*6 in x 3.7 in*).

The Beta Combo Press is produced in one version, nominally 230 Volts AC for the `European` market.

1.1 What did you receive?

The Beta Cap Press has been placed in a cardboard box and held in place with a special liner. The following articles should have been delivered:

- Beta Cap Press complete with mains cable and plug
- Beta Cap Press Users' Handbook
- Cap attachment: 15 cm x 9.3 cm (*6 in x 3.7 in*)
- Any extra items ordered

If there is any damage or any article is missing, please contact your supplier immediately.

1.2 Specifications of the Beta Cap Press

The Beta Cap Press is a manually operated heat press for transfer printing and material fusing. It is ideal for medium volume production.

The work area of the Beta Cap Press is 15 cm x 9.3 cm (*6 in x 3.7 in*).

Specifications

Power consumption	0.5 kW
Power supply	230 Volts AC
Working temperature	70-235°C
Display timer range	0 – 9.59 min
Machine height open	80 cm (<i>31.5 in</i>)
Machine height closed	43 cm (<i>17 in</i>)
Machine width	28 cm (<i>11 in</i>)
Machine depth	52 cm (<i>20.5 in</i>)
Machine dimensions	52(L) x 28(W) x 80(H) cm (<i>20.5(L) x 11(W) x 31.5(H) in</i>)
Working area	52(L) x 28(W) x 80(H) cm (<i>20.5(L) x 11(W) x 31.5(H) in</i>)
Table size	15 x 9.3 cm (<i>6 x 3.7 in</i>)
Press pad dimensions	15 x 9.3 cm (<i>6 x 3.7 in</i>)
Net weight	15 Kg (<i>33 lbs.</i>)
Gross weight	21 Kg (<i>46 lbs.</i>)
Fuses	3.15A
A-weighted noise level	<70dB(A)

1.3 Safety

The Beta Cap Press has been equipped with various safety features to ensure operator safety.

The time/temperature controller has a built in facility giving error messages in the event of faults with the element heating and control system.

1.4 Safety Tips

If required, our customer service team can arrange maintenance service.

- ◆ **The Beta Cap Press** meets the European Legislation standard. Under normal conditions accidents are rare. However, listed below are some practical points to ensure your safety.
 - ◆ **Always switch off** and isolate the mains supply (i.e. remove plug) before undertaking any maintenance work.
 - ◆ **Keep other people** away from the machine during use.
 - ◆ **Ensure that there is** sufficient space around the machine. Cables and connections must not get jammed. Although the heat radiation of the press is low, there should be enough space for cooling down.
 - ◆ **Avoid contact** with the press element.
 - ◆ **Make sure** that before you change the attachments **ALL** power to the machine is switched off; preferably completely remove the plug from the mains socket.
 - ◆ **Only when the** heating element is **COLD** should changing the attachments be undertaken. **Carefully** unlock and unplug the lead from the base of the machine, **carefully** remove the head attachment by pulling out the safety catch* and place in a safe area, making sure that you do not catch or scratch the TEFLON® covered heating element.
 - ◆ Replace with the required new attachment (Cap or Pocket) carefully pull out the safety catch on the head, insert the runners and make sure that it is in its locked position and is secure. Carefully insert the plug into its socket and lock into place. **Check** that both head and plug are secure, **only then** switch on the power to the machine.
 - ◆ When fitting the tables, unscrew the nut under the table and remove, fit the table and tighten securely, making
-

Safety Tips (cont.)

sure that the heating element fits correctly over the pressing pad so as not to cause any undue wear.

*(Situating on the left side of the insulation cover.)

- ◆ **DO NOT REMOVE THE BASE BOARD OR CONTROLLER UNLESS QUALIFIED TO DO SO** - touching internal parts is dangerous and may cause shock hazard. All electrical connections inside covers are live. Never operate Press with any covers and/or guards removed.
- ◆ **PROTECT THE MAINS CABLE** - damage to the mains cable may cause fire or shock hazard. When unplugging, hold by the plug only and remove carefully. Take care that the mains cable does not come into contact with the heat plate (or moving parts of the mechanism) during operation of the machine.
- ◆ **OPERATING AMBIENT TEMPERATURE RANGE** - the operating ambient temperature range is 0°C - 35°C, (32°F - 104°F) and humidity of 20 - 80%.
- ◆ **MACHINE FUSES** - type: ultra rapid (FF) fuses 20 mm 230 VAC max. 3.15 Amps.
- ◆ **WARNING - THIS APPARATUS MUST BE EARTHED (GROUNDED)**
- ◆ **CAUTION**
This machine gets hot whilst operating. Take care not to touch any surfaces that are labelled "Caution this plate is HOT".
- ◆ **NEVER** change attachments whilst heating elements are hot or when the machine is switched on.
- ◆ **MACHINE OPERATION**
Only suitably trained personnel should operate this machine.

This machine is designed to be operated by one operator only.

For Safety use both hands to move the handle up and down.

Do not allow the handle to move upward, by the effect of the springs, without a hand on it.

Safety Tips (cont.)

Keep fingers away from **trapping points** in the arm - lever toggle mechanism. Using both hands on the handle keeps the hands safe.

Contact your print media suppliers to ascertain whether **fumes** are given off during the transfer process, and if so what precautions are needed for operator safety. These may include **air extraction** and / or masks for personnel.

Please refer to page 16 for an illustration of the Beta Cap Press machine.

2. Installation

2.1 Transport instructions

The machine comes to you placed in a cardboard box and held in place with a special liner. If you have to transport the machine at any time it is recommended that you use a similar box and packing methods. Please let the machine cool down and lower the handle to the locked position.

2.2 Installing the machine

2.2.1 Remove all packaging from the heat press.

2.2.2 Check to ensure that no damage has been caused to the machine during transit.

2.2.3 Place the machine on a sturdy horizontal surface that is within easy reach of the operator and allow space for the handle to move up to the loading position. Ensure that no items vulnerable to heat radiation are too close to the machine and that local lighting is adequate.

2.2.4 If necessary attach machine to base.

2.3 Electrical requirements

The Beta Cap Press should be connected to the mains supply, (nominally 230VAC for the European Market) by the mains cable provided and a suitable plug. A qualified person should carry out this work.

The press is designed for 230VAC \pm 50/60 hertz and requires exclusive use of a power outlet rated for at least 5 Amps (Europe).

Ensure that the supply rating on the machine specification plate corresponds with your local supply and that the correct plug is fitted.

MAINS LEAD

The wires in this mains lead are coloured in accordance with the following code:

230 VAC {
Green and Yellow: EARTH
Blue: NEUTRAL
Brown: LIVE

Electrical requirements (cont.)

As the colours of the wires in the mains lead of this apparatus may not correspond with the coloured markings identifying the terminals in your plug, proceed as follows:-

1. **The wire coloured green and yellow** must be connected to the terminal in the plug, which is marked by the letter E, or by the safety earth symbol coloured green, or green and yellow.
2. **The wire coloured blue** must be connected to the terminal, which is marked with the letter N, (Neutral connector).
3. **The wire coloured brown** must be connected to the terminal, which is marked with the letter L, (Live connector).

NOTE:

Replacement of the mains cable must be done by a competent service engineer.

HEATING ELEMENT

The heating element fitted to this press is rated at 0.5 kW.

Never connect to any outlet or power supply having a different voltage/frequency from that on the machine data plate.

2.4 Adjusting the pressure

This press is fitted with a pressure-adjusting unit, which enables the heat plate assembly to be raised or lowered by use of a pressure adjustment knob located on the top of the machine:

- a) **To increase pressure** or to use thinner materials turn knob clockwise.
- b) **To decrease pressure** or to raise the heat plate assembly to enable thicker materials to be used, turn the adjustment knob anticlockwise.

NOTE:

DO NOT adjust the pressure when the machine is clamped shut.

CAUTION

Never increase the pressure to the extent of requiring undue force to lower the toggle/heat plate assembly into the lock position, as this will place excessive stress on the press frame, resulting in permanent damage to the press.

2.5 Adjusting the time and temperature

Please refer to page 17 showing the operation of the control unit.

3. How to Operate the Beta Cap Press

3.1 Starting with the Beta Cap Press

3.1.1 Plug into your supply outlet and switch supply on.

N.B. Please ensure the mains plug is easily accessible to the operator so that in the event of a fault the machine can be unplugged.

3.1.2 Turn on the Beta Cap Press; the on/off switch is to the right of the controller. Set the machine controls as necessary. See instructions for adjusting the pressure, **page 8**, and the operation of the time temperature unit, **page 16**. When the set temperature is steady in the display the machine is ready to use

3.1.3 Make sure that before you change the attachments ALL power to the machine is switched off; preferably completely remove the plug from the mains socket.

Only when the heating element is **COLD** should changing the attachments be undertaken. **Carefully** unlock and unplug the lead from the base of the machine, **carefully** remove the head attachment by pulling out the safety catch* and place in a safe area, making sure that you do not catch or scratch the TEFLON® covered heating element.

Replace with the required attachment, carefully pull out the safety catch on the head, insert the runners and make sure that it is in its locked position and is secure. Carefully insert the plug into its socket and lock into place. **Check** that both head and plug are secure, **only then** switch on the power to the machine.

When fitting the tables, unscrew the nut under the table and remove, fit the required table and tighten securely, making sure that the heating element fits correctly over the pressing pad so as not to cause any undue wear.

*(Situated on the left side of the insulation cover.)

3.2 Working with Heat Transfer Materials

This section is divided into Transfer Marking/Transfer Printing and Heat Bonding and Fusing.

First ascertain from the supplier of the material that it is suitable to be used, and obtain the correct heat and time dwell setting for the material and transfer.

Working with Heat Transfer Materials (cont.)

Approximate settings may be as follows:-

3.2.1 Transfer Marking

200°C (392°F) - Heat setting 3 to 5 seconds - Time dwell setting

NOTE: Transfer marking is usually for the marking of materials for identification purposes and should not be confused with the transfer printing, as mentioned in the next section.

3.2.2 Transfer Printing

190°C-200°C (374°F-392°F) - Heat setting 20 to 30 seconds - Time dwell setting

NOTE: Always ascertain from the supplier of material and transfer paper, that the material to be used is suitable for, and has been prepared for transfer printing.

3.2.3 Heat Bonding - Fusing

140°C-200°C (284°F-392°F) - Heat setting 5 to 15 seconds - Time dwell setting
--

3.2.4 Ensure that the heat setting and dwell time setting are correct for the material being used.

3.2.5 Adjust the pressure setting of the machine by rotating the adjusting knob situated at the rear of the machine. (See exploded diagram in this manual.) Clockwise for more pressure, anticlockwise for less pressure.

3.2.6 Adjust the position of the silicone pad table to align the cap with the heat plate by loosening the locking knob situated underneath the silicone pad table, positioning it as required (front to back) and retightening the locking knob.

3.2.7 Hook the cap under the cap-tensioning arm and pull the cap onto the silicone pad table.

3.2.8 Place the transfer in the desired position on the work.

3.2.9 Gently pull the handle forward into the lock position, using both hands for safety and ensuring the work is firmly clamped between the heat plate and pressure pad.

3.2.10 When the pre-set dwell time has been reached, a buzzer will sound. The heat plate should then be lifted by pushing the handle back to its full extent. The handle should be held until the up position is reached to remove the possibility of injury to the operator's face from an uncontrolled upward movement of the handle.

Working with Heat Transfer Materials (cont.)

- 3.2.11** For safety reasons, it is necessary to push the handle into the locked position after it is lifted. This will ensure against the accidental lowering of the heat platen handle.

3.3 Pressing Pad Assembly

The pressing pads normally supplied with this machine are silicone rubber. The pressing pad must be maintained in good condition at all times and replaced when showing signs of wear. A worn pressing pad will always affect the quality of printing/fusing. Do not insert items into the machine, which would tend to cut the pressing pad, i.e. buttons, pins, press-studs or zips.

Never allow the hot heat plate to rest on the pressing pad when the press is not being used as the pad may be damaged.

IMPORTANT NOTE:

The pressing pad supplied with the machine is of the correct thickness. Using a thicker pad may invalidate your warranty.

3.4 Shutting Down the Machine

To shut down the machine, turn off the ON/OFF switch on the right of the machine. The handle should be in the up position.

After shutting off the machine, it should not be switched on again for 30 seconds.

3.5 Fault Diagnosis

This machine has a built in fault diagnosis. The display may show the following:

1. H-F

If the element of the heat press, or the thermal cut-out go open circuit, after approximately 20 minutes the display will show "H-F" and a buzzer will sound. If this display is seen, contact your machine supplier immediately.

2. Probe Fault

If the probe goes open circuit, the display will show "P-F" immediately, and a buzzer will sound. Contact your machine supplier immediately.

Fault Diagnosis (cont.)

CAUTION

In all fault conditions switch off the power to the machine and unplug the machine from the electrical supply before contacting your machine supplier.

3.6 Hints and Tips

Transfer Printing

Extra care should always be taken to ensure that transfer paper is placed print down onto the article, as mistakes will result in the heat plate becoming soiled with ink and spoiling following work.

When transfer printing, it may be found advantageous to cover the press pad with paper to prevent strike-through of surplus ink, particularly when printing thin material as surplus print on the pressing pad cover can also strike back on the following work.

Transfer Paper/Motifs Fail to Print Out Correctly

Check:-

1. **Heat and time dwell** settings are correct.
2. **Article** having transfer applied is locked in contact between pressing pad and heat plate.
3. **Pressing pad** is in good condition, and making complete contact over the whole area of the heat plate. See Pressing Pad details.

“Ghosting” (Double Image) of Transfer Prints

Check:-

1. **Material being used** has been correctly heat set for transfer printing.
 2. **Material being used** does not shrink during printing process, i.e. measure material before and after printing.
 3. **Transfer paper** does not move after printing process upon lift off of the heat plate.
 4. **If possible**, use adhesive coated paper, particularly to overcome fabric shrinkage.
 5. **By pre-shrinking** of material in press before transfer printing.
-

3.7 Heat Plate Temperature Measurement

Testing of the Heat Plate for temperature consistency or fault condition should only be undertaken after consulting Charterhouse Holdings PLC, and then only using a wired Digital Thermometer (*please see note below).



***Please Note:**

The Digital Thermometer with external probe is suitable for surface, air and immersion/penetration measurement, which is required for all Adkins heat presses.

Laser Thermometers only measure air surfaces which can be misleading due to currents of hot air floating on the surface of the heat plate.

4. Maintenance of the Machine

4.1 Daily Maintenance

For good press results it is important to keep the press surfaces clean. Wipe the surface of the heat plate with a dry non-abrasive cloth before use when the plate is cold.

When heat plates are hot and not in use, keep open position away from the silicone pad.

4.1.1 Make sure that all attachments not being used are carefully stored. The TEFLON® covered heating element should be 'bubble wrapped' or similar for protection and to prevent marking. Unless the element is free from marks and scratches you will not get good transfer results. (Undue damage to the heating element is not covered by the machine warranty).

4.2 Periodic Maintenance

Put a few drops of oil onto the various pivot pins and the pressure adjusting screw every three months.

Periodically clean the TEFLON® coated heat platen with a non-abrasive piece of cloth. Stubborn stains may be cleaned, when platen is cool, with mineral spirits.

4.3 General Maintenance

The following checks should be carried out at regular intervals by a qualified and competent person:-

- Electrical connections
- Mechanical moving parts

Any enquiries to: enquiries@aadkins.com

4.4 Cleaning

First unplug the machine. Clean the outside of the machine frequently with a clean, moist cloth. This may conveniently be carried out when the machine is cold.

To prevent soiling of substrate, periodic wiping of entire exterior machine, including platens, with a clean rag is recommended. If necessary, use mineral spirits for cleaning a cold machine. Since mineral spirits are flammable, use precautions at all times and keep away from sparks, flames or hot heat platen.

5. Machine Drawings and Diagrams

On the following pages are the schematic diagrams for the Beta Cap Press machine.

- 5.1 General Layout..... Page 16**
- 5.2 Control Unit – Operation..... Page 17**
- 5.3 Exploded Diagram and Parts List..... Page 18**
- 5.4 Machine – Electrical Diagram..... Page 19**
- 5.6 Controller - Electrical Diagram..... Page 20**

5.1 General Layout

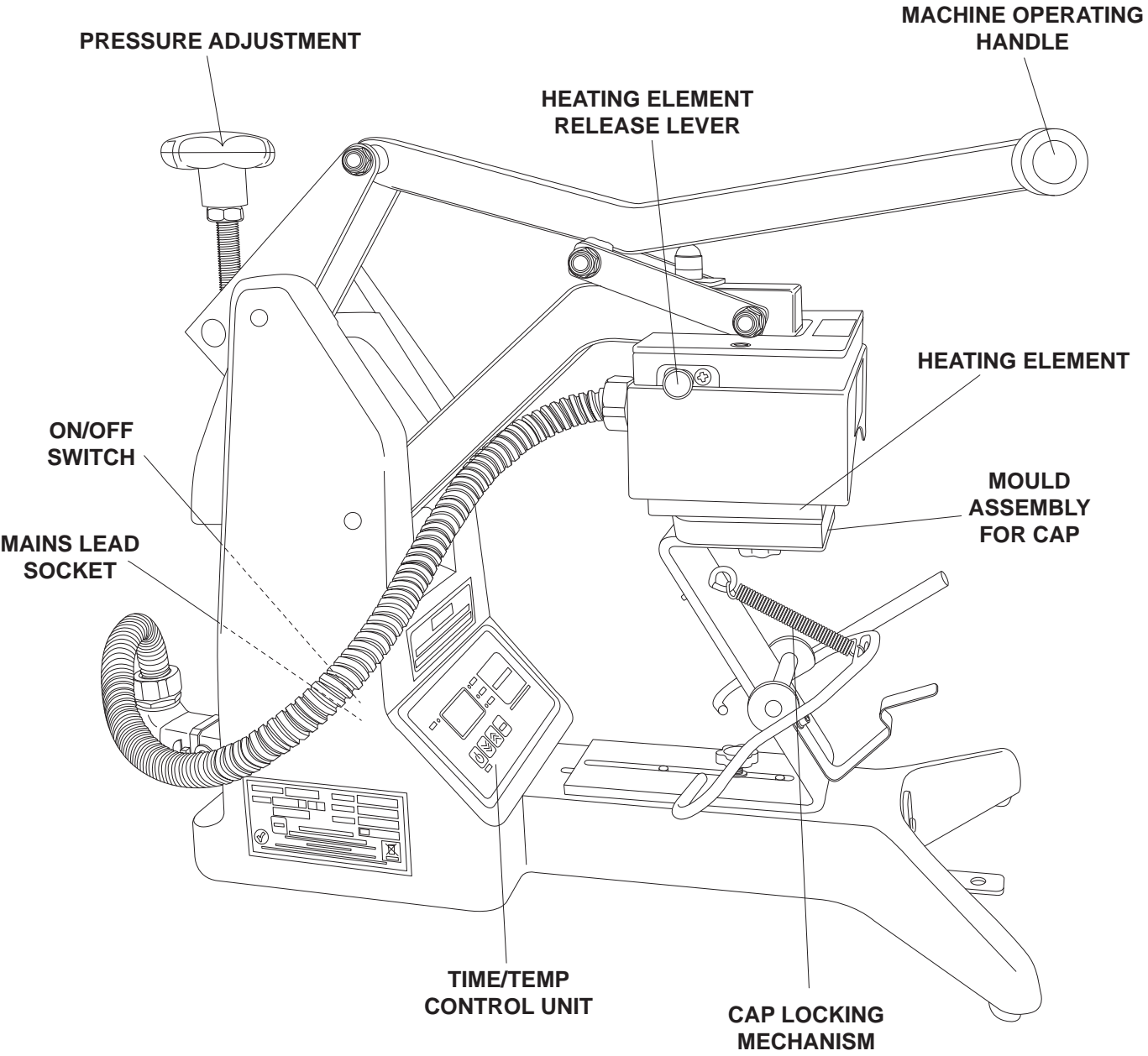

5.2 Operation Of Control Unit, Setting Time and Temperature

(The head must always be in the up position before the controller is set)



Setting Temperature

1. Switch on Press; Display and 'TEMP' indicator will light up.
2. Press 'MODE' button to select 'Set' on indicator.
3. The Display will start flashing.
4. Use the 'UP' and 'DOWN' arrow buttons to set the required temperature.
5. When you have set the required temperature the Display will stop flashing and the 'SET' indicator will go out.
6. Press the 'ON/OFF' button to start the Press heating to the selected temperature. The 'ACT' indicator will light up.



Setting Time

1. Switch on Press; Display and 'TEMP' indicator will light up.
2. Press 'MODE' button twice to select 'SET' and 'TIME' on indicator.
3. The display will start to flash.
4. Use the 'UP' and 'DOWN' arrow buttons to set the required time.
5. When you have selected the required time the Display will stop flashing and the 'SET' and 'TIME' indicators will go out.
6. Press the 'ON/OFF' button to start the Press. The 'ACT' indicator will light up.

5.3 Exploded Diagram and Parts List

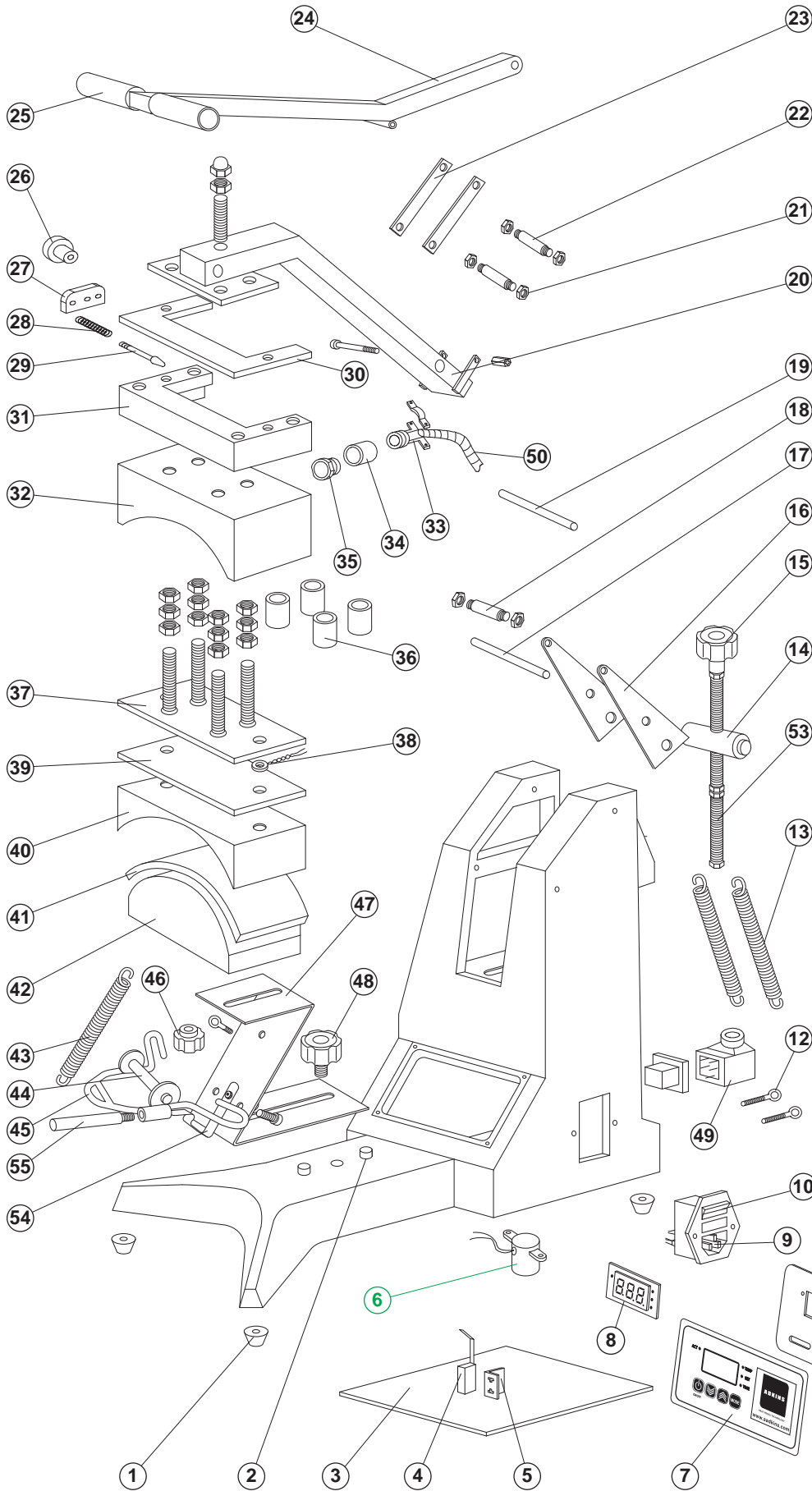

ITEM	DESCRIPTION	QU.	PIN No.
1	RUBBER FEET	4	SW33
2	DOWELS	4	NCC74
3	BASE BOARD	1	NCC37
4	MICRO SWITCH	1	BMC462
5	MICRO SWITCH BRACKET	1	NCC31
6	BUZZER	1	BUZ1*
7	OVERLAY FACIA	1	SWC101
8	FRONT BOARD	1	BMC332/A
9	FILTER FUSE UNIT	1	SWC36
10	3.15A FUSE	1	SWC51
11	MAINS LEAD & PLUG 230 V (UK)	1	BMC618
	MAINS LEAD & PLUG 120 V (USA)	1	BMC618/A
	MAINS LEAD & PLUG 230 V (EU)	1	NCC620
12	SCREW EYE	3	BMC477
13	ARM SPRING	1	NC36/A
14	PIVOT BUSH	1	NCC26
15	HANDLE WHEEL	1	BMC507
16	TOGGLE SIDE PLATES	2	NCC24
17	ARM PIVOT PIN	1	NCC15
18	LEVER TOGGLE PIN	1	NCC28
19	TOGGLE PIVOT PIN	1	NCC14
20	ARM	1	CPC01
21	M8 NYLOC NUTS	6	BC27
22	ARM TOGGLE PIN	2	NCC27
23	LEVER SIDE PLATES	2	NCC25
24	LEVER HANDLE	1	NCC23
25	HANDLE	2	BMC19/H
26	PLUNGER KNOB (CAP & POCKET)	1	CPC08
27	PLUNGER RETAINING PLATE	1	CPC10
28	CAP PLUNGER SPRING	1	CPC09
29	CAP PLUNGER	1	CPC07
30	CAP SLIDE PLATE COVER	1	CPC06
31	CAP SLIDE PLATE	1	CPC05
32	CAP INSULATION COVER	1	CPC03
33	SHORT THREAD GLAND	1	BC55
34	COUPLING	1	CPC12
35	COUPLING NUT	1	CPC13
36	SPACER	4	NCC21
37	CLAMP PLATE	1	CPC04
38	TYPE 'K' THERMO COUPLE	1	FP3057/5
39	ELEMENT 240 V x 500 W	1	SWC14
	ELEMENT 120 V x 500 W	1	SWC14/A
40	FEMALE MOULD	1	NCC52
41	SILICON PAD	1	NC79
42	MALE MOULD	1	CPC02
43	TENSION ARM SPRING	1	NCC35
44	TENSION ARM AXLE	1	NCC12
45	TENSION ARM	1	NCC11
46	KNURLED KNOB	1	BMC224
47	'Z' PIECE	1	CPC11/A
48	KNURLED KNOB M6 x 33	1	NCC73
49	PLUG/SOCKET	1	CPC24
50	CABLE SLEEVING	1	CPC28
51	FACIA PLATE	1	SWC102
52	POWER BOARD	1	BMC322/B
53	M12 STUDDING	1	STUD1
54	TENSION ARM RETAINING SPRING	1	NCC18
55	'Z' PIECE HANDLE	1	NCC17

* For older machines only

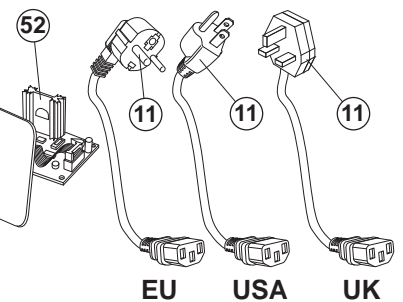

5.4 Electrical Diagram

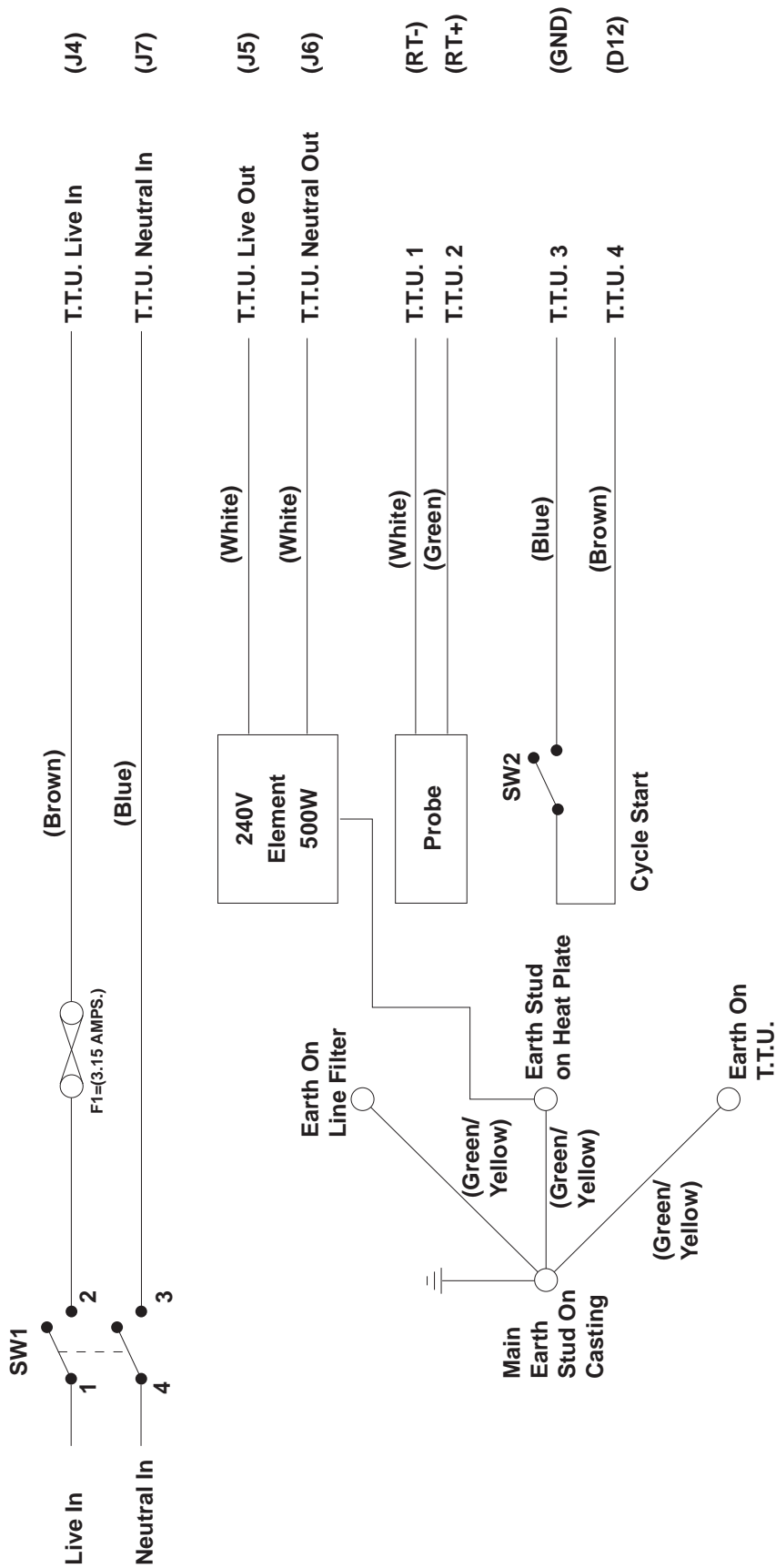

KEY:
 T.T.U. = Time Temperature Unit
 SW1 = ON/OFF SWITCH
 SW2 = MICROSCHWITCH

The fuse rating and element power are 240V

5.5 Controller Electrical Diagram

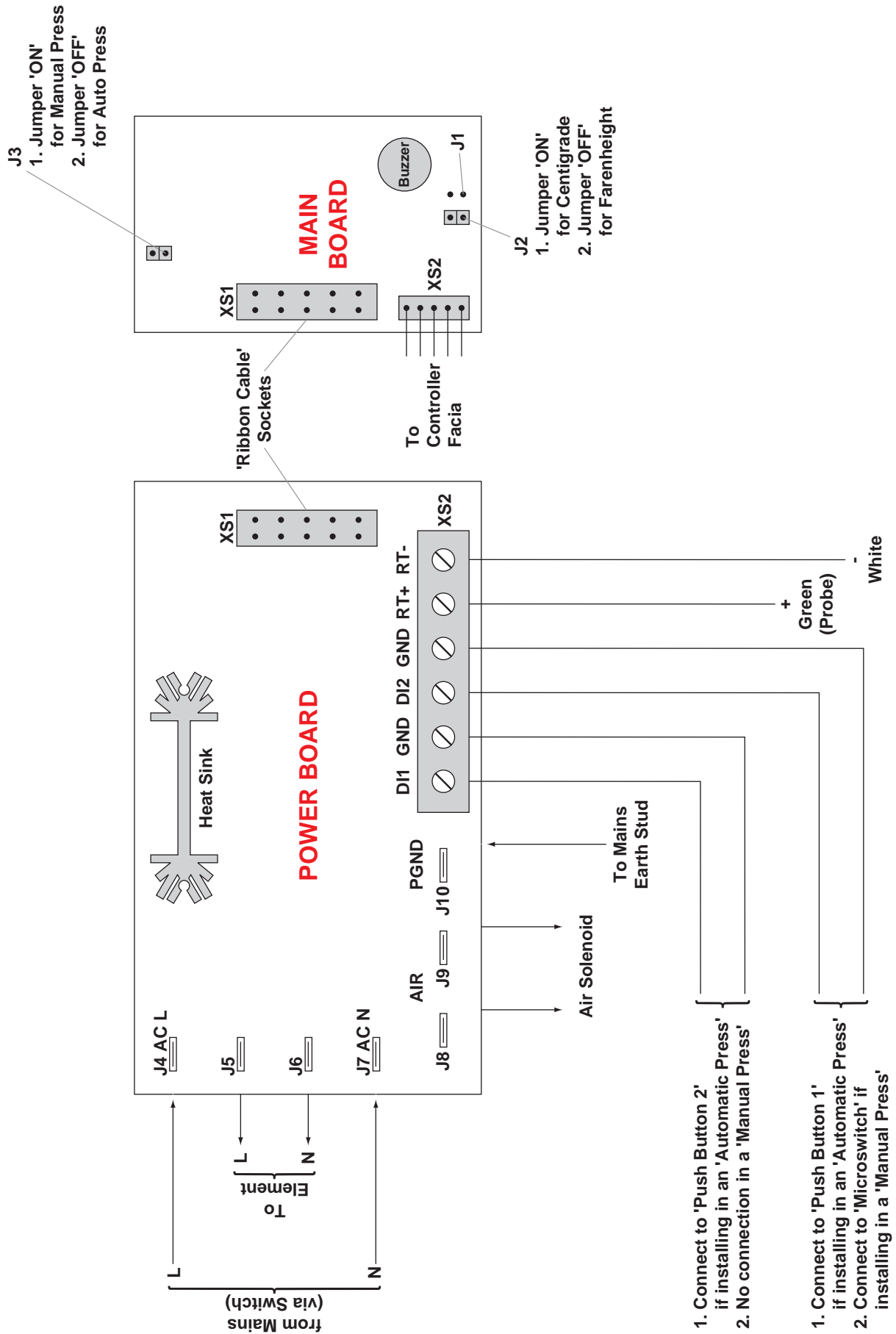

6. Design Change

With the policy of constant improvement and/or modification to meet changing conditions, the right is reserved to change the design and/or specifications at any time without prior notification, and therefore specifications may vary and not be in accordance with this manual.

7. Guarantee (Limited Warranty)

Charterhouse Holdings PLC warrants that the press is free from defects in material and workmanship for a period of 12 months from the date of supply to the customer. The machine comes with a one year warranty on parts and 90 days labour.

This warranty covers all parts to repair the defects, except when damage results from misuse or abuse, accident, alteration or negligence or when a machine has been improperly installed.

If a press covered by warranty should need to be returned to the factory for examination and repair, if on-site component replacement is not possible, Charterhouse Holdings PLC will make every effort to repair the customers press. The warranty will only be effective when Charterhouse Holdings PLC authorises the original purchaser to return the machine to the factory and only when the product upon examination has proven to be defective.

Should in our opinion any part of this press be defective in materials or workmanship, it will be replaced or repaired free of charge, provided that the press has been installed and operated in the correct manner and not subjected to misuse. If Charterhouse Holdings PLC authorise a replacement press, the warranty of the replacement press shall expire on the anniversary date of the original machines invoice to the customer.

In order for this warranty to be effective, no return of machine or parts may be made without prior factory authorisation. (This will exclude any travelling and/or carriage costs which will be charged at our discretion).



This is the sole warranty given by the company; there are no warranties, which extend beyond the description on the face hereof. The seller disclaims any implied warranty of merchantability and/or any implied warranty of fitness for a particular purpose; the buyer agrees that the goods are sold "as is". Charterhouse Holdings PLC not warrant that the functions of the press will meet the customer's requirements or expectations. The entire risk as to use, quality and performance of the press lies with the customer. (No claim of any kind shall be greater than the sale price of the product or part to which the claim is made).

In no event will Charterhouse Holdings PLC be liable for any injury, loss or damage, including loss of profits, destruction of goods or any special, incidental, consequential or indirect damages arising from the use of the press or accompanying materials. This limitation will apply even if Charterhouse Holdings PLC or its authorised agent had been advised of the possibility of such damage.



HEAT PRESS TECHNOLOGY

A. ADKINS AND SONS LIMITED DECLARATION OF CONFORMITY

Application of Council Directives:	European Low Voltage Directive (LVD), European Machinery Directive (MD), Electro Magnetic Conformity (EMC)
Standards to which Conformity is Declared:	(LVD): <u>EN 60204-1:2018</u> (MD): <u>EN ISO 12100:2010 2006/42/EC Annex1</u> (EMC): <u>EN 61000-6-2:2019</u>
Manufacturer's Name:	<u>A. Adkins and Sons Limited</u>
Manufacturer's Address:	High Cross, 18 Lancaster Road, Hinckley, Leicestershire LE10 0AW United Kingdom.
Type of Equipment:	Beta Cap Heat Press
Standards Compliance:	 
Model Number:	NCC
Serial Number:
Year of Manufacture:

I, the undersigned, hereby declare that the equipment specified above conforms to the above directives and standards.

Place: Hinckley, United Kingdom

Signature: 

Date:

Full Name: Marie McMahon

Position: General Manager